

Installation, Operation and Maintenance

2" Commercial Water Softener Systems

Series: CWS-200HF, CWSP-200HF



CWS-200HF Simplex Systems



CWSP-200HF Duplex, and Triplex Progressive Systems

Congratulations on your purchase of this Watts® commercial water softening solution.

You have made a great choice to protect your plumbing system against the damaging effects of hard water. This system has been engineered for trouble free operation and produced using top quality components. Simple programming, corrosion resistant mineral tank(s) and an easy to service design ensures this system will be durable and easy to maintain.

Thank You!

The Watts Team

Softened water provides a wide variety of benefits such as reducing the potential of lime scale formation in boilers, water heaters and heat exchangers to protecting the remainder of the plumbing system from costly maintenance and down time associated with the negative effects of hard water.

⚠ WARNING

Please read carefully before proceeding with installation. Your failure to follow any attached instructions or operating parameters may lead to the product's failure. Keep this Manual for future reference.

**⚠ WARNING**

If you are unsure about installing your Watts water softener contact a Watts representative or consult a professional water treatment dealer or plumber.

You are required to thoroughly read all installation instructions and product safety information before beginning the installation of this product. **FAILURE TO COMPLY WITH PROPER INSTALLATION AND MAINTENANCE INSTRUCTIONS COULD RESULT IN PRODUCT FAILURE WHICH CAN CAUSE PROPERTY DAMAGE, PERSONAL INJURY AND/OR DEATH.** Watts is not responsible for damages resulting from improper installation and/or maintenance. Local building or plumbing codes may require modifications to the information provided. You are required to consult the local building and plumbing codes prior to installation. If this information is not consistent with local building or plumbing codes, the local codes should be followed.

Save manual for future reference.

Refer to the enclosed for operating parameters to ensure proper use with your water supply.

- As with all plumbing projects, it is recommended that a trained professional water treatment dealer or contractor install the water conditioning system. Please follow all local plumbing codes for installing this water conditioning system.
- Inspect the water conditioning system for carrier shortage or shipping damage before beginning installation. Replace any damaged component immediately, before beginning installation.
- Use caution when installing soldered metal piping near the water conditioning system. Heat can adversely affect the system's components.
- Use only lead-free solder and flux for sweat-solder connections, as required by state, province and federal codes.
- Handle all components of the system with care. Do not drop, drag or turn components upside down.
- Be sure the floor under the system is clean, level and strong enough to support the system while in operation.
- Install the system in an indoor/protected area. Not to be installed outdoors.
- Do not attempt to treat water over 110°F (43°C) or under 34°F (1°C) with the system.
- Always connect the system to the main water supply pipe before the water heater.
 - The valve will withstand transportation and storage temperatures of -13 °F (-25 °C) to 131 °F (55 °C) and for short periods up to 158 °F (70 °C). If valve has been exposed to freezing conditions let valve warm up to room temperature before running water through it. The valve has been packaged to prevent damage from the effects of normal humidity, vibration and shock.
- Do not install in direct sunlight as overheating of electronics may occur and ultraviolet rays from the sun may cause damage.
- Do not use on water that is microbiologically unsafe or of unknown quality. This system will not make microbiologically unsafe water safe. Water that is unsafe must be treated separately from this conditioner.
- Operating ambient temperature: 34° to 100°F (1° to 43°C).

- Operating water pressure range : 25 to 125psi (171 kPa to 8.6 bar).
- All plumbing connections to the system should be made using industry accepted best practices. Plumbing tape or paste may be used on metal inlet and outlet plumbing connections. Do not use paste type pipe thread sealants on the system's plastic plumbing connections.
- Do not use petroleum-based lubricants such as Vaseline[®], oils or hydrocarbon-based lubricants on O-rings or valve seals. Use only 100% silicone lubricants.
 - Hydrocarbons such as kerosene, benzene, gasoline, etc may damage products that contain o-rings or plastic components. Exposure to such hydrocarbons may cause the products to leak. Do not use the product(s) contained in this document on water supplies that contain hydrocarbons such as kerosene, benzene, gasoline, etc.
- Use only the power transformer supplied with this water conditioning system.
- All electrical connections must be completed according to local codes.
- The power outlet must be grounded.
- For installations where plastic plumbing is used, install an appropriate grounding strap across the inlet and outlet piping of the building's metal plumbing to ensure that a proper ground is maintained.
- To disconnect power, unplug the AC adapter from its power source.
- Observe drain line requirements.
- Support the full weight of the plumbing system with pipe hangers or other means.
- Do not allow this water conditioning system to freeze. Damage from freezing will void this water conditioning system's warranty.
- It is established that when daytime water pressure exceeds 80psi (5.5 bar), the maximum pressure rating of 125psi (8.6 bar) can be exceeded. A pressure regulator must be installed on this system or warranty is voided.
- Periodic cleaning and maintenance is required for system to function properly.
- Observe all warnings that appear in this manual.
- Keep the media tank in the upright position. Do not turn upside down or drop. Turning the tank upside down or laying the tank on its side can cause media to enter the valve.
- Use only regenerants designed for water conditioning. Do not use ice melting salt, block salt or rock salt.

How To Use This Manual

This installation manual is designed to guide the installer through the process of installing and starting up this commercial water conditioning systems.

This manual is a reference and will not include every system installation situation The person installing this equipment should have:

- Training on the control valve.
- Knowledge of water conditioning and how to determine proper control settings.
- Adequate plumbing skills.

* Vaseline[®] is a registered trademark of Unilever.

⚠ WARNING

Do not use with water that is microbiologically unsafe or of unknown quality without adequate disinfection before or after the system.

Table of Contents	Page
Safety Information	3
How To Use This Manual	3
Introduction	4
Project Data Sheet	5
System Specifications	6
Set Up	7
Operating Parameters	7
System Installation	8-9
Start Up Instructions	9
Installation Diagrams	10-12
Controller Electrical Connections	13
Wire Instruction	14
Controller Programming and Operation	15
Button function and programming key sequence	15
Programming quick reference	16-18
Typical user screen	19-20
Setting time of day and date	21
Notification	21
Errors	21
Main menu screen	22
System setup screens	23-27
Cycle setup screens	28-29
Expansion setup screens	30-32
Installer setup screens	31-34
Diagnostic screens	35-37
Valve history	38
Custom motorized drive timing	39
Replacing the Media	40
Replacement Parts - Major System Components	41-42
Replacement Parts - CWS-200HF Front Cover and Drive Assembly	43
Replacement Parts - CWS-200HF Control Valve Body	44
Replacement parts - CWS-200HF Brine System	45
Replacement Parts - 2" Stainless Steel Mech/Electronic Meter	46
Troubleshooting	47-55
Water Softener Flow Diagrams	54-58
Injector Flow Data and Injector Draw Rates	57-60
MAV Control	61-62
Warranty	64

Introduction

Principals of Softening- Ion Exchange

In nature, water acts as a solvent that dissolves substances it comes in contact with such as solid rock. When water dissolves limestone rock, which is composed of calcium and magnesium, the solid calcium and magnesium become ions. This means they have been dissolved into the water and are now a liquid. An ion with a positive electrical charge is called a cation. Calcium and magnesium hardness ions in water are positively charged cations. When water dissolves enough calcium and magnesium hardness cations it is classified as hard water, which can cause lime scale build up in plumbing systems, water spots, and an increase in soap and cleaning product usage.

Ion exchange water softening is a process where an ion exchange resin is used to effectively exchange calcium and magnesium hardness cations for sodium cations in the water.

New, or freshly regenerated, ion exchange resin is saturated with sodium cations. As calcium and magnesium hardness cations come in contact with the ion exchange resin, they attach to the resin and sodium cations are released into the water. This is possible because the hardness cation are more attracted to the ion exchange resin than the sodium cations. Therefore, scale forming calcium and magnesium cations have been exchanged for non-scale forming sodium cations as the water is treated. If the calcium and magnesium content of the water is reduced to less than 17.1 mg/L, that water is classified as soft water.

Eventually the ion exchange resin will become exhausted, depleted of sodium, and will need to be regenerated with a sodium brine solution to restore its capacity to soften water. This system includes a flow meter to track treated water volume and initiate the regeneration process before resin exhaustion occurs.

Regeneration occurs automatically and consists of 5 steps:

Step 1- Backwash

Approximate Duration 10 Minutes- Fresh water flow is directed upward through the resin bed, to remove solid particles the resin bed has captured, sending them to drain.

Step 2- Brine Draw

Approximate Duration 15-20 Minutes- Brine water is drawn from the brine tank, rinsed over the ion exchange resin, driving away the calcium and magnesium cations and restoring sodium cations within the resin. Calcium and magnesium is sent to drain.

Step 3- Slow Rinse

Approximate Duration 40-45 Minutes- Once the brine tank is emptied of brine water, fresh water will continue to rinse over the resin and rinse calcium and magnesium cations to drain.

Step 4- Second Backwash (Optional)

Approximate Duration 8 Minutes- Fresh water flow is directed upward through the resin bed to mix the resin directly after slow-rinse.

Step 5- Rapid Rinse

Approximate Duration 10 Minutes- After the conclusion of slow rinse, fresh water will rinse over the resin to ensure any residual sodium brine has been cleaned from the resin before it returns to service.

At the conclusion of Rapid Rinse:

Simplex single tank systems return to the "In Service" position. Multi tank systems remain in the "Stand By" position.

Step 6- Brine Tank Refill

Approximate Duration User Adjustable- In this final step of regeneration, water is added back into the brine tank so that a brine solution can be prepared for the next regeneration.

Project Data Sheet

Installation Summary

Installation Date: _____

Installation Location: _____

Installer(s): _____

Phone Number: _____

Application Type: (Softener) _____ Other: _____

Water Source: _____

Water Test Results: _____

Hardness: _____ Iron: _____ pH: _____

Other: _____

Misc:

Service Flow Rates: min. _____ max. _____

Tank Size: Diameter _____ Height: _____

Resin or Media Volume: _____

Resin or Media Type: _____

Capacity: _____

Salt or Fill Setting per Regeneration: _____

Brine Tank Size: _____

Control Valve Configuration:

Valve Type: _____

Valve Part Number: _____

Valve Serial Number: _____

Regenerant Refill Control: _____ gpm/lpm

Injector Size: _____

Drain Line Flow Control: _____ gpm/lpm

System Specifications

Dimensions - Weights

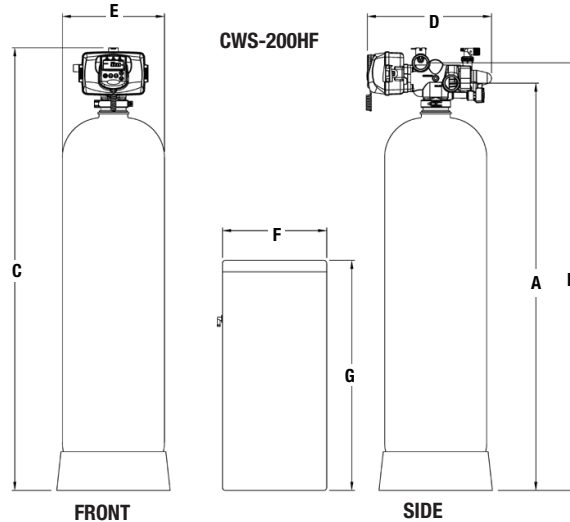

Series CWS-200HF

MODEL NO.	DIMENSIONS												WEIGHTS			
	A		B		C		D		E		F		G		lb	kg
	in.	mm	in.	mm	in.	mm	in.	mm	in.	mm	in.	mm	in.	mm		
M4558WH-NH	77¼	1962	79⅞	2021	84	2134	24	610	24¼	616	30	762	50	1270	710	322
M4559WH-NH	77¼	1962	79⅞	2021	84	2134	30	762	30¼	768	39	991	48	1219	1160	562
M4560WH-NH	77¼	1962	79⅞	2021	84	2134	36	914	36¼	921	39	991	48	1219	1560	707

Specifications

MODEL NO.	MINERAL TANK RESIN SIZE	GRAVEL	BRINE TANK TANK SIZE	SALT FILL	SOFTENING CAPACITY		LBS. SALT PER REGENERATION		FLOW RATE & PRESSURE			
					MAX	MIN	MAX	MIN	SERV GPM	DROP PSI	BKW GPM	
M4558WH-NH	24" x 72"	10	200 lbs.	30" x 50"	1200	300 K	200 K	150	60	75/97	15/25	15
M4559WH-NH	30" x 72"	15	400 lbs.	39" x 48"	2200	450 K	300 K	225	90	88/113	15/25	25
M4560WH-NH	36" x 72"	20	500 lbs.	39" x 48"	2200	600 K	400 K	300	120	97/126	15/25	35

NOTICE Capacities are based on resin manufacturer's data and are dependent upon influent water TDS, temperature, bed depth, and flow rates. Feed water must be free of oil and color. Pipe size, tank size, and space requirements are in inches. Capacities and flow rates expressed above are per tank. Flow rates listed at 25psi drops are for intermittent peak flow rates and are not to be used as continuous flows.

NOTICE Flow rates listed above are based on pressure drop only. Selecting a system based on pressure drop alone does not guarantee that the system will provide adequately softened water. System selection should be based on resin quantity, capacity required, feed water analysis, and application requirements.

Ordering Information for 2" Simplex (CWS-200HF), Duplex, and Triplex (CWSP-200HF) Softeners

MODEL NO.	ORDERING CODES	DESCRIPTION	SPACE REQUIRED D X W X H	WEIGHT LBS
M4558WH-NH	68110445	10 Cubic Foot 2" Simplex Softener with Flow Meter	30" x 60" x 96"	710
M4559WH-NH	68110446	15 Cubic Foot 2" Simplex Softener with Flow Meter	39" x 75" x 106"	1160
M4560WH-NH	68110447	20 Cubic Foot 2" Simplex Softener with Flow Meter	39" x 81" x 107"	1560
M4558WHTI-NH	68110800	10 Cubic Foot 2" Progressive Duplex Softener with Flow Meter	59" x 65" x 98"	1420
M4559WHTI-NH	68110801	15 Cubic Foot 2" Progressive Duplex Softener with Flow Meter	74" x 73" x 104"	2320
M4560WHTI-NH	68110802	20 Cubic Foot 2" Progressive Duplex Softener with Flow Meter	80" x 85" x 108"	3120
M4558WHTR-NH	68110808	10 Cubic Foot 2" Progressive Triplex Softener with Flow Meter	59" x 97" x 98"	2130
M4559WHTR-NH	68110809	15 Cubic Foot 2" Progressive Triplex Softener with Flow Meter	74" x 109" x 104"	3480
M4560WHTR-NH	68110810	20 Cubic Foot 2" Progressive Triplex Softener with Flow Meter	80" x 127" x 108"	4680

NOTICE The information contained herein is not intended to replace the full product installation and safety information available or the experience of a trained product installer. You are required to thoroughly read all installation instructions and product safety information before beginning the installation of this product.

Set Up

Unpack system and make sure all components are accounted for according to the diagram below according to your specific series number. If any components are missing or damaged contact your Watts representative. If they can not be reached contact Watts customer service at 1-800-659-8400.

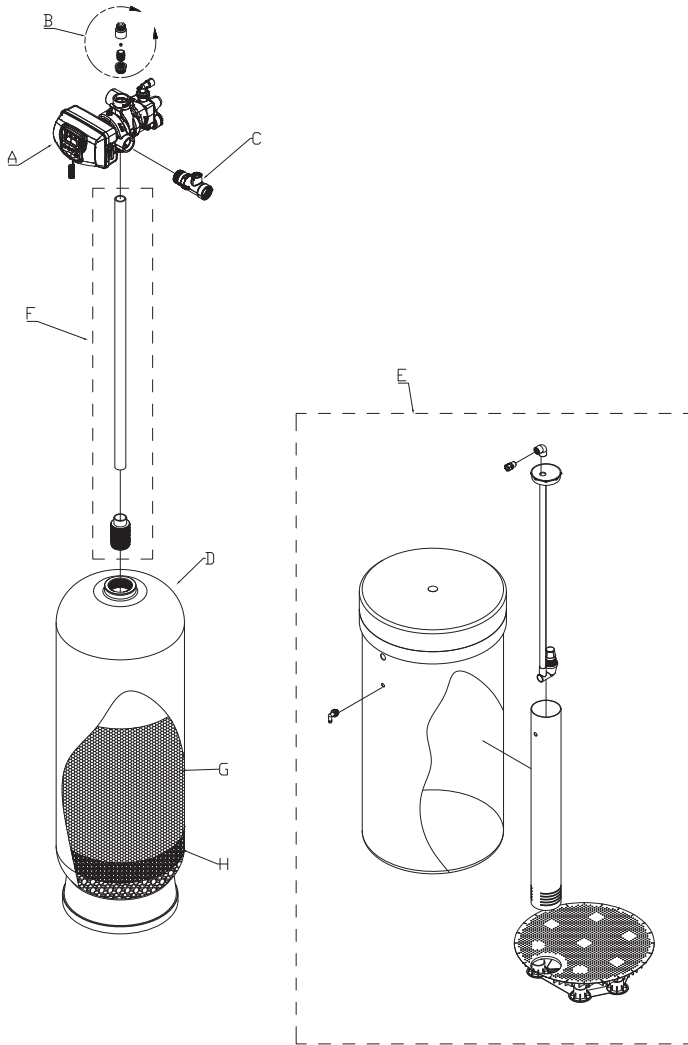

Operating Parameters

pH	6 to 10
Hardness (maximum)	Depends on customer's acceptable hardness leakage level
Water Pressure	25psi to 125psi (171 kPa to 8.6 bar)
Temperature	40 - 110°F (4 - 43°C)
Free Chlorine (maximum)	1mg/L
Iron (maximum)	1mg/L
Oil and H ₂ S	None Allowed
Turbidity	Less than 5.0 NTU
Total Dissolved Solids	Must be below 750mg/L for the softener to produce less than 1 grain per gallon soft water
Minimum Ambient Temperature	40°F/4°C
Maximum Ambient Temperature	110°F/43°C
Maximum Humidity	75%
Power Supply Input Voltage	100-120 VAC
Power Supply Input Frequency	50/60 Hz
Power Supply Output Voltage	15 VDC
Power Supply Output Current	500 mA (per control valve)
Maximum Altitude	2,000 meters above sea level
Water known to have heavy loads of dirt and debris may require pre-filtration prior to the water softening system.	
For all other guideline information please contact your Watts representative.	

QUANTITY OF MAJOR COMPONENTS BY SERIES

COMPONENT LABEL	COMPONENT	CWS-200HF SIMPLEX	CWSP-200HF DUPLEX PROGRESSIVE	CWSP-200HF TRIPLEX PROGRESSIVE
A	Number of Control Valves	1	2	3
B	Number of Drain Line Flow Controllers*	1	2	3
C	Number of Flow Meters	1	2	3
D	Number of Mineral Tanks	1	2	3
E	Number of Brine Tanks	1	2	3
F	Number of Distributor Tubes*	1	2	3
G	Resin**	Quantity Varies Depending On System Size		
H	Gravel**	Quantity Varies Depending On System Size		

*Drain line flow controllers may come factory assembled on control valve's drain port depending on size. Distributor tubes ship inside mineral tanks.

**Resin and gravel are supplied in bulk on pallets. The proper amount is supplied for the system.

Divide resin and gravel equally between the number of mineral tanks. See page 6 Specifications table for media quantity by tank size.

System Installation

Pre-Installation Considerations

- A minimum of 25psi of water pressure is required for regeneration valve to operate effectively.
- A continuous 115 volt, 60 Hertz current supply is required. Make certain the current supply is always hot and cannot be turned off with another switch.
- Condition of existing plumbing should be free from lime and iron buildup. Piping that is built up heavily with lime and/or iron should be replaced. If piping is clogged with iron, a separate iron filter unit should be installed ahead of the water softener.
- The softener should be located close to a drain.
- Always provide for the installation of a bypass valve.
- The full weight of the plumbing system must be supported by pipe hangers or other means.
- Do not install the system where it would block access to the water heater, main water shutoff, water meter, or electrical panels.
- Install the system in a place where water damage is least likely to occur if a leak develops.
- If applicable, use di-electric unions where dissimilar metals are present.

NOTICE

The main control valve and all plumbing connections have right-hand threads. Turn clockwise to install.

NOTICE

If O-ring lubricant is required, only use a silicone based compound formulated for potable water O-ring applications. Watts recommends Ordering Code #68102757 Silicone Lubricant. The use of other types of lubricants may attack the control's plastic or rubber components. Petroleum-based lubricants can cause swelling in rubber parts, including O-rings and seals.

⚠ WARNING

Do not exceed water pressure of 125psi (8.6 bar). Do not exceed 110°F (43°C). Do not subject unit to freezing conditions.

General Installation Instructions

1. Turn off water heater(s).
2. Turn off the main water supply to the building and open a treated water faucet (cold and hot) to relieve any pressure within the plumbing system.
3. Place the mineral tank(s) in the desired installation location. Make sure that the location is level and sturdy enough to support the weight of the system once it is in operation.
4. After the mineral tank(s) have been placed into their final position, and will not need to be moved again, load the mineral tanks with resin and gravel media following the instructions below:
 - 4a. Inspect the distributor screens for damage, and make sure all screens are present before loading the mineral tank with media. Before proceeding with installation, replace any damaged components immediately.
 - 4b. Cap the top open end of the distributor tube with tape and plastic sheeting to keep all media and foreign debris from entering the distributor tube. This cap must be secure and not come off during media loading.
 - 4c. Place the distributor tube, screen end down, into the mineral tank and center it in the bottom. The top of the distributor tube should be flush with the top of the tank. Test the tape cap to make sure it can not come off during the media loading process.
 - 4d. For systems 24" in diameter and larger, fill the mineral tank $\frac{1}{3}$ full with water to prevent breakage of the distributor tube screens during the media loading process. This step is not required for tanks smaller than 24" in diameter.
 - 4e. Make sure the plastic and tape cap is secure to the top of the distributor tube, place a funnel on the top of the tank and load first the gravel (if different sizes of gravel are used load the largest gravel first, then the smaller gravel) then the softening resin into the tank. The cap must not come off of the distributor tube during the loading of the media.
 - 4f. Remove the funnel from the top of the tank and plastic cap and tape from the top of the distributor tube. **DO NOT PULL UP ON THE DISTRIBUTOR TUBE** when removing the cap. The distributor tube top must remain flush with the top of the tank.
 - 4g. Clean any media from the threads and top of the mineral tank. Media in the threads and on the O-ring sealing surface of the tank can cause tank thread damage and prevent the control valve's O-ring seal from sealing properly.
 - 4h. Lubricate the O-rings on the bottom of the control valve (distributor tube port O-ring and top of tank O-ring). Use nonpetroleum based silicone lubricant only.
 - 4i. Press the factory supplied black upper diffuser into the base of the control valve.
 - 4j. Place the control valve on top of the tank. When performing this step, seat the top of the distributor tube inside the distributor port located on the bottom of the control valve first, then press the control valve down until the control valve threads come in contact with the tank threads. This ensures that the distributor tube is properly seated into the bottom of the control valve.
 - 4k. Tighten the control valve onto the tank with a clockwise rotation. Be careful not to cross thread the control valve to tank connection or over tighten it. A hand tight fit is appropriate for the control valve torque. **DO NOT** use a wrench. Tank or control valve damage could result. **DO NOT** apply thread sealant or plumbing tape on the control valve to tank threaded connection.
- 5*. Install flow meter(s). For CWS-200HF Simplex and CWSP-200HF Progressive Series systems, apply a suitable thread sealant to the male threads of the meter(s) and with the meter's direction of flow arrow pointing in the direction of water flow, install the meter(s) directly into the outlet port(s) of the system control valve(s).
- 6*. Rotate meter(s) clockwise to tighten, by gripping the meter(s) on the hexagonal surface with a wrench, and continue to tighten the water meter(s) until the meter dome(s) is pointing straight up.

System Installation

- 7*. Connect the cold water supply to the inlet port of the water softening system's control valve(s). When constructing the supply line, install an inlet water isolation valve and plumbing union fitting(s) (user supplied) in the supply line of each control valve(s) and close the isolation valve. The union fitting(s) should be located between the isolation valve(s) and the systems inlet port(s).
- 8*. Install an inlet water sample port in the supply line and close it.
- 9*. If risk of vacuum exists, install Watts # 0556031 vacuum relief valve in the supply line to protect the system against vacuum damage.
- 10*. Connect the outlet water connection of the water meter(s) for CWS-200HF and CWSP-200HF systems, to the water line requiring softened water. When constructing this outlet water line, install an outlet water isolation valve and plumbing union fitting (user supplied) in the outlet line of each control valve and close the isolation valve. The union fitting(s) should be located between the outlet of the control valve(s) and the outlet isolation valve(s).
- 11*. Install an outlet water sample port on the outlet water line of the system and close it.
- 12*. Install a bypass valve between the inlet and outlet plumbing water lines and close it.
- 13*. If not already factory installed on the control valve, attach the drain line flow controller(s) directly to the control valve's drain port(s). See page 10 for connection detail. The flow arrow on the drain line flow controller(s) must point towards the drain receptacle. Only plumbing tape is allowed on the drain line flow controller fitting threads.

⚠ WARNING

Operating a system without a drain line flow controller will cause all media to flow out of the system through the drain line.

- 14*. Construct the drain line routing it to an appropriate drain receptacle abiding by all local building and plumbing codes. DO NOT construct drain line to elevations that exceed 4 feet above the drain port of the control valve, or reduce the drain line diameter to smaller than that of the drain line flow controller. Install a plumbing union fitting in the drain line close to the drain line flow controller. The drain line must be anchored to the floor.
- 15*. Connect the brine tank to the water softener's control valve(s) brine port using the factory supplied fittings and tubing. See page 10 for connection detail. The brine tank should set on a common elevation as the mineral tank and within distance so that it can be reached by the length of factory supplied brine tubing. Add enough water (6") to the brine tank so that water covers the top of the air check. DO NOT add salt to the brine tank at this time.
16. Connect meter cable(s) into meter dome(s) according to Figure 1. Connect the other end of the meter cable(s) to the control valve's Flow meter port located on the control valve's controller of the control valve the meter is plumbed into. See page 14 for Flow meter port location.
17. Plug in the 15V power supply transformer(s) into a 115V 60Hz power outlet and program the system according to the System Type and application requirements following the Control Valve Programming section of this manual.
18. If applicable, install a metal bonding strap across metal inlet and outlet plumbing lines to maintain electrical continuity.

The system is now ready for Start Up.

*See Installation Diagrams pages 10-12 of this manual for additional information.

Start Up Instructions

1. Ensure all inlet and outlet isolation valves and the bypass valves are in the closed position and the treated water faucet hot and cold side are in the open position.
2. Open the main water supply valve to the building.
3. Check for leaks and repair as needed.
5. Press and hold Regen button for >3 sec to manually start the regen cycle, place the system into the backwash position. Once the system cycles into the backwash position, unplug the control valve from the power outlet to keep the system in the backwash position.
6. Open the inlet isolation valve slightly until water can be heard flowing through the isolation valve and allow the mineral tank to fill with water. Air will come out of the drain line until the mineral tank is full of water. Once water flow at the drain line is observed, fully open the inlet valve and allow water flow to drain for 10 minutes to flush the resin bed of any color. If water at the drain shows any discoloration, continue to flush the resin bed until water at the drain is clear.
7. After resin bed flushing is complete, plug the system back into the power outlet so that it will return to the service position. Repeat steps 5, 6 and 7 on the other tank(s) if this is a Series CWSP-200HF Progressive system.
8. For CWSP-200HF series systems, connect the factory supplied inner-connecting communication cable(s) between the COMM IN and COMM OUT ports of the control valve's controllers shown on page 14.
9. Put the appropriate amount of water in the brine tank(s). This is accomplished by manually cycling the control valve(s) to cycle step 4 "Brine Tank Refill" and allowing a complete brine tank refill cycle to conclude. This step must be done for each brine tank in the system only after the proper brine tank refill time has been programmed into each controller.
10. Put the appropriate amount of salt in each brine tank. Do Not fill the salt level past the brine well lid.
11. Fully open the outlet isolation valve(s).
12. Ensure the bypass valve is in the closed position.
13. Check for leaks and repair as needed.
14. Allow water to flow from the hot and cold side treated faucet until all air has been purged from the plumbing system. Then close both the hot and cold side treated water faucet.
15. Turn on water heaters.

Start up is now complete and the system is ready for operation.

Figure 1
Stainless Steel 2" Meter

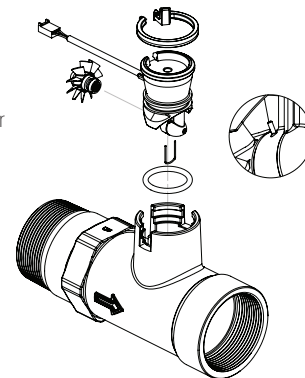

Installation Diagrams - Series CWS-200HF Simplex Systems

Installation Reference Notes For All System Installation Drawings:

1. All dimensions are on page 6 of this manual & unless otherwise noted are ± 1 inch (25mm).
2. All items shown in phantom line are to be provided by others.
3. All dimensions are subject to change without any notice.
4. Install unions fittings on inlet, outlet & drain plumbing connections.
5. Provide a 2 feet minimum clearance above mineral tank for filling media.
6. A GFCI equipt electrical outlet should be provided within 5 feet of equipment location.
7. Use dielectric unions on plumbing connections of control valve when dissimilar metals are present.
8. Provided system shall not be subject to any vacuum. If risk of vacuum is present, install siphon break on drain line & install vacuum relief valve Watts ordering code # 0556031 on inlet line.
9. Brine tank dimensions shown on table are factory selected for use with the specified system size.
10. Do not install drain line directly to a drain. For proper drain connection follow all national, state and local codes. Do not

11. The full weight of the piping and valves must be supported by pipe hangers or other means.
12. Inlet and outlet headers need to be sized according to flow rate requirements by others.
13. Power requirements: 115V/60Hz 500 mA per control valve unless otherwise specified.
14. Brine tank must be located within 10 feet of system control valve and on a common floor elevation with mineral tank to ensure proper brine draw operation.
15. Use factory supplied brine tubing. Do not use smaller diameter tubing than what is supplied.
16. Limit inlet pressure to not exceed maximum published operating pressure.

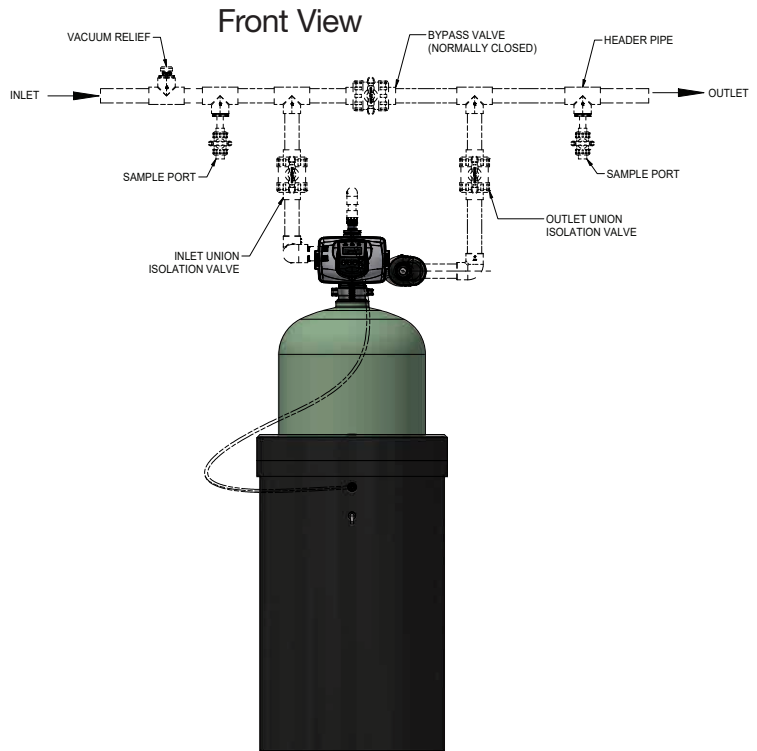
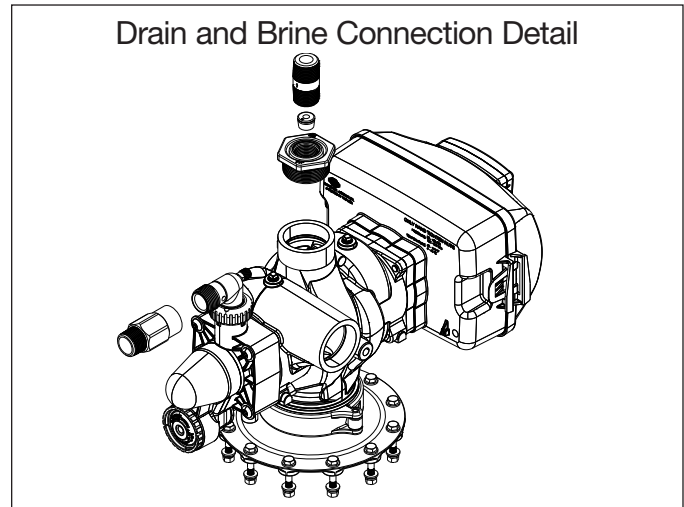
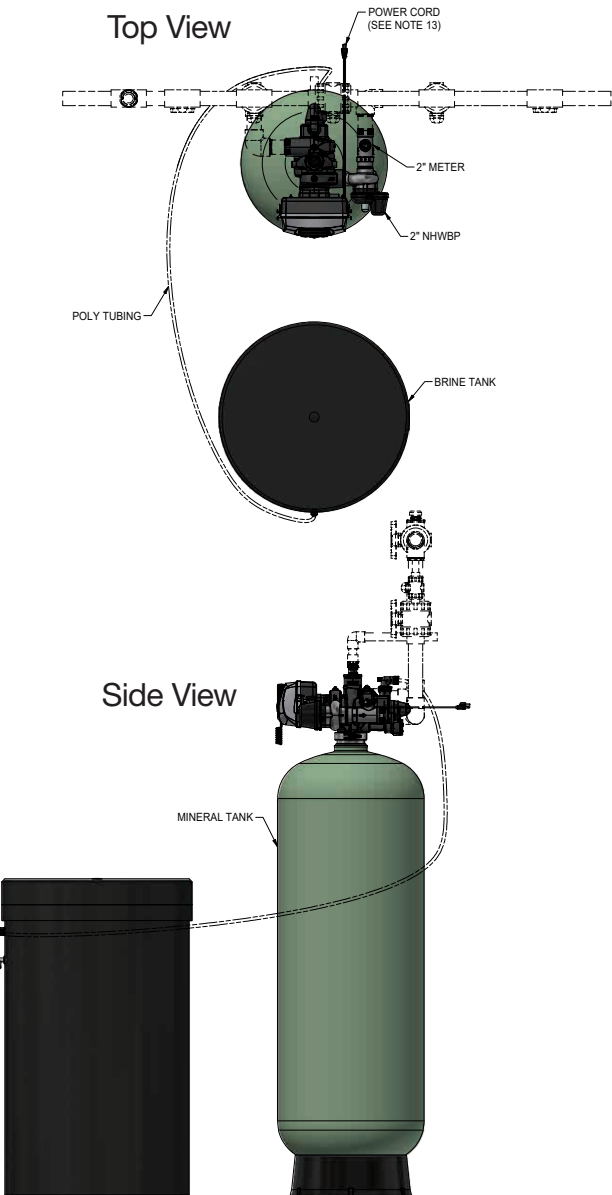

Installation Diagrams - Series CWS-200HF Duplex Systems

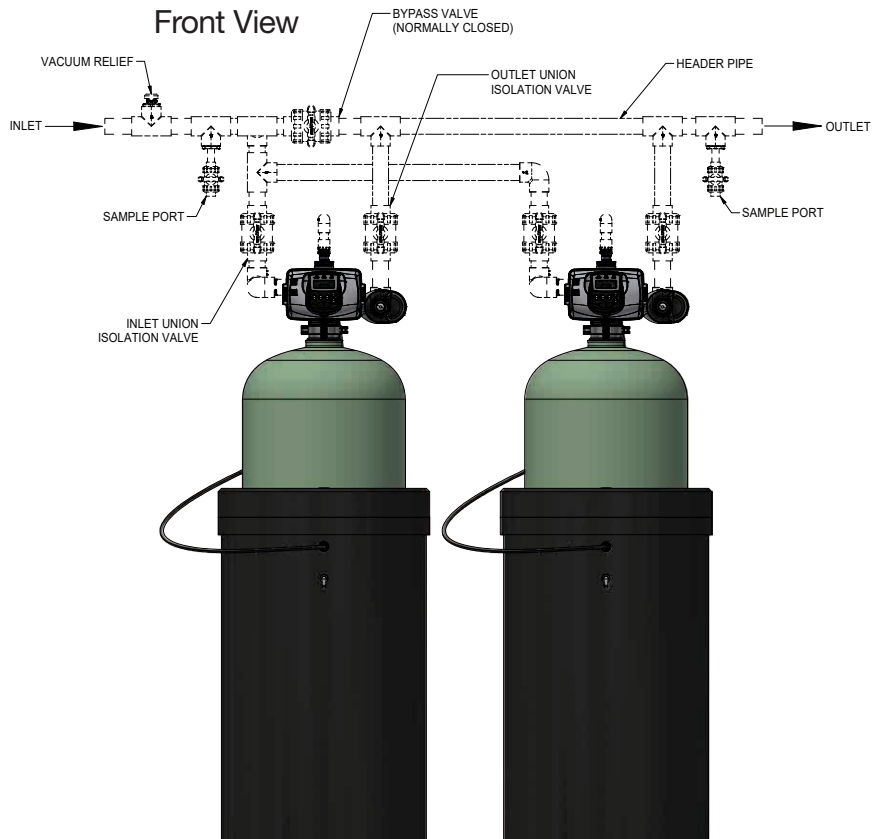
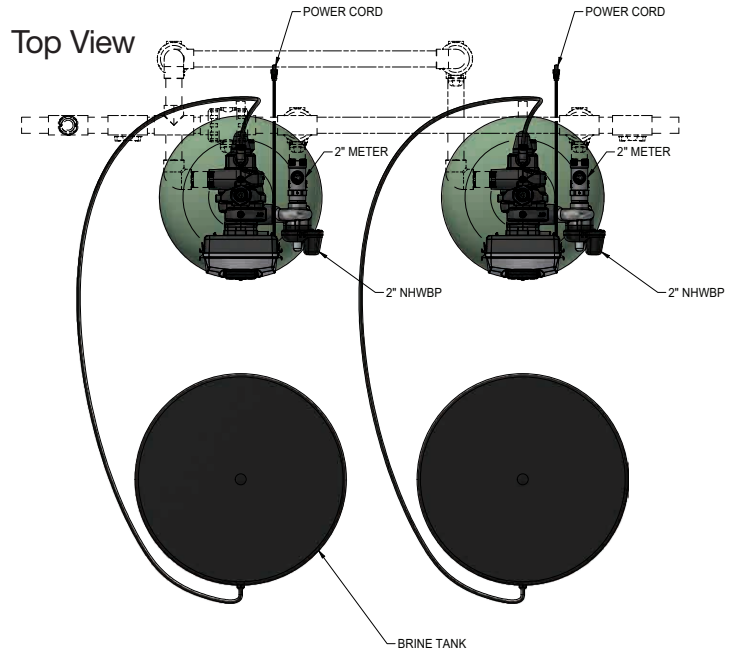
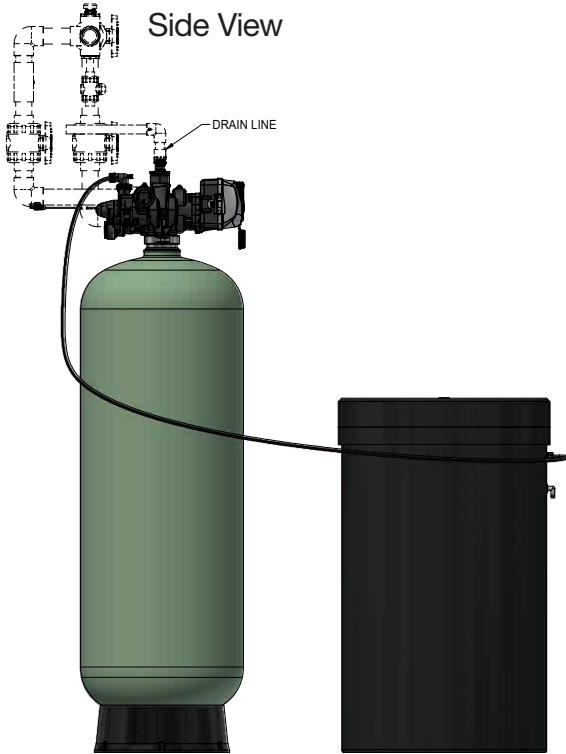

Installation Diagrams - Series CWS-200HF Triplex Systems

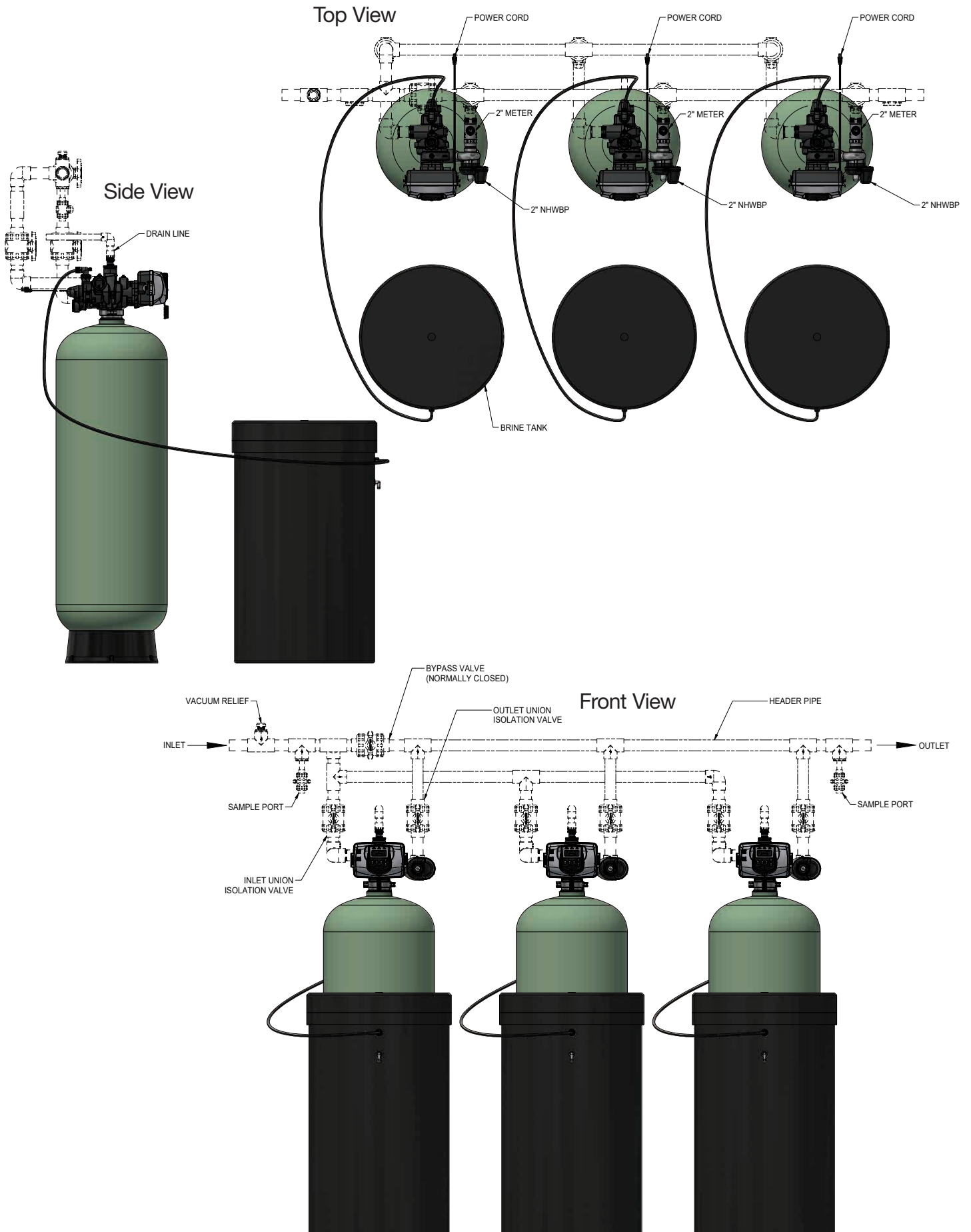

Controller Electrical Connections

Electrical Connections:

NOTICE Power supply and drive motor cables include cable harnesses that are already connected to the control board.

If these cable need to be disconnected from the control board, pull on the white connectors while rocking side to side. **DO NOT** pull on the wires. To reconnect, push the white cable connectors firmly into position on to the control board until they are fully mated.

See Controller Electrical Connection Diagram below for additional information.

WIRING FOR CUSTOM POWER ADAPTER

1. Cable should be one unshielded pair of 22AWG, UV resistant UL2464 compliant wire.
2. Connector details:
 - a. Terminate end with one Hirose black housing, P/N DF3-4S-2C and four Hirose pins, P/N DF3-22SC.
 - b. Pin 1 = Ground from power supply (Black)
Pin 2 = Jumper to Pin 3
Pin 3 = Jumper to Pin 2
Pin 4 = 24 VDC from power supply (White)

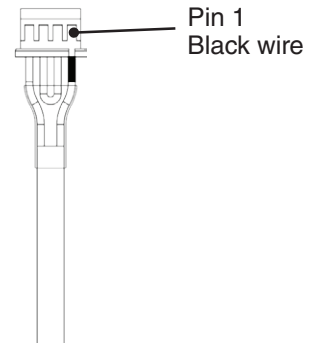

WARNING

As with any electrical product, care should be taken to guard against the potential risk of fire, electric shock, and injury to persons.

CUSTOM METER WIRING

- 1) Terminate end with a Molex series 2695 housing, part number 22-01-3037 and (3) Molex series 41572 (or 40445) pins, part number 08-65-0805 (or 97-00-44).
- 2) Auxilliary meter must be able to operate on 5VDC
Pin 1 = +5 VDC
Pin 2 (Center) = Signal
Pin 3 = Ground
- 3) Acceptable pulse input is 0.1 – 999 pulses/gallon, or 0.4 –519 pulses / liter.

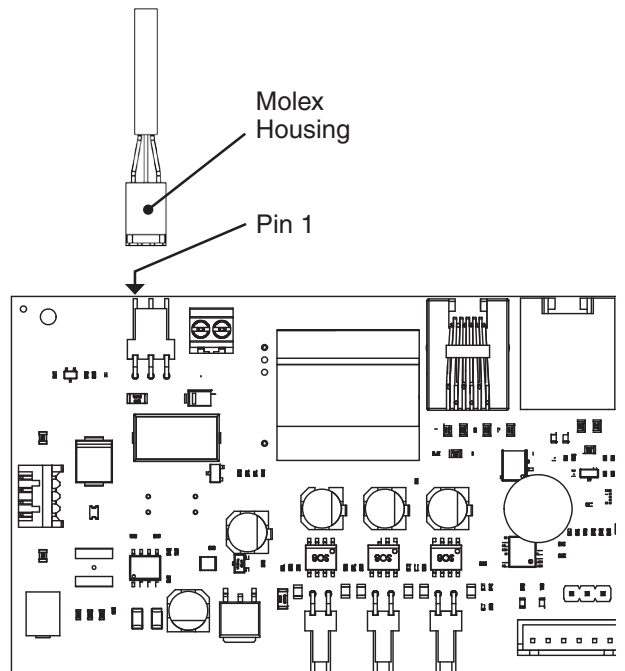

Wiring Instruction

MAIN PC BOARD

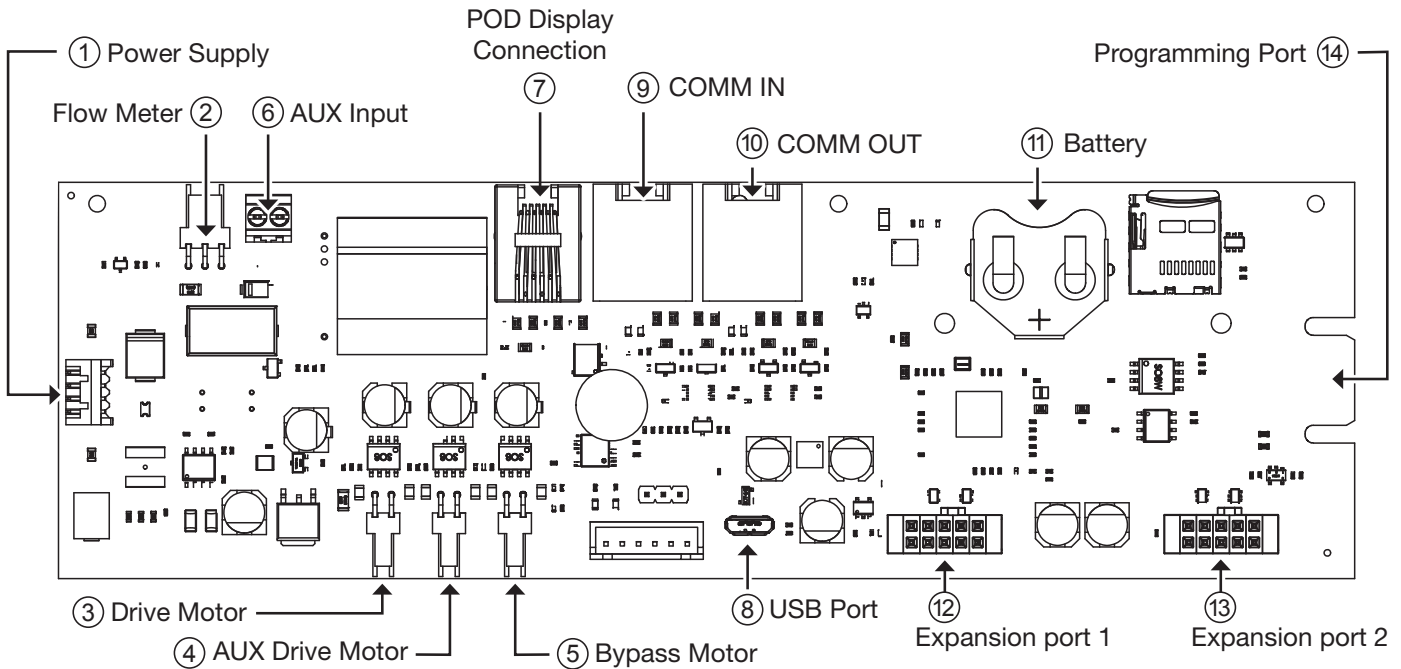

Item	Board label	Description
1	POWER	Connect to proper power supply
2	FLOW	Input for the unit's flow meter
3	REGEN	Motor circuit used to power the main drive of the unit during regeneration
4	AUX DRIVE	2nd Drive circuit for factory motorized isolating valve (MAV or NoHBP)
5	BYPASS	Drive circuit for factory motorized isolating valve (MAV or NoHBP)
6	AUX IN	Connect to external dry contacts to control functionality based on the unit's settings **Wiring units inputs in parallel requires matching each units polarity**
7	DISPLAY	Connection for POD display
8	USB	USB connection for future use. Must use adapter cable to convert from micro-USB connection to USB female adapter
9	COMM IN/MODBUS	RJ45 communication port for communication to LEAD or previous LAG. Must use straight through RJ45 cable with T-568B wiring for communication to LEAD or previous LAG. If setup as LEAD, can be used for Modbus communication with proper cable wiring and RS485 communication adapter.
10	COMM OUT	RJ45 communication port for communication to LAG units. Must use straight through RJ45 cable with T-568B wiring for communication to LAG.
11	BAT1	CR2032 battery for keeping clock powered during power loss
12	EXP1	Connection for the optional expansion boards
13	EXP2	Connection for the optional expansion boards
14	DATA	Factory use only

Controller Programming and Operation

BUTTON FUNCTION AND PROGRAMMING KEY SEQUENCE

●
STANDBY

Standby LED

- Signals that a unit is not in service, or regen
- Flashes to alert status conditions
 - 1 per second indicates flow had been detected while the unit was off-line

●
ON LINE

Online LED

- Signals that a unit is currently in service

●
REGEN

Regen LED

- Signals that a unit is currently in regen

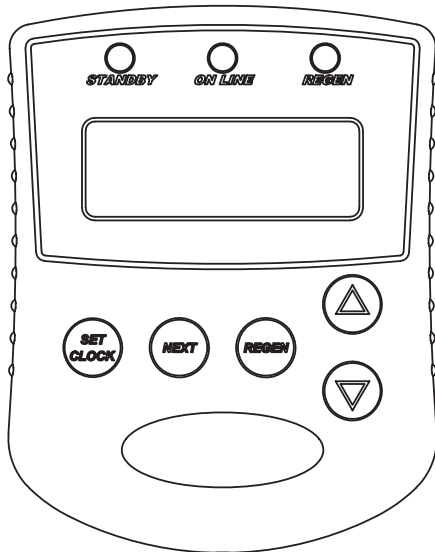

Set clock from User Screens
Exit & save from setup or program screens.



Move to the next display



Change variable being displayed



Toggles scheduled regen time on/off.
Holding for >3 sec, starts immediate regen (Immediate regen is the only option if set to Immediately regenerate upon 0 gallons).
Moves back one display while in program mode.



Reset
Holding for >3 seconds initiates a reset. The software version is shown and the piston returns to the "home" position, re-synchronizing the valve.



History Reset
Holding the Set Clock & Regen buttons for >3 seconds initiates a totalizer or history reset.



Key sequence to lock and unlock programming screens

Programming Key Sequences	
Programming Level	Buttons
Installer	Next Up
Main Setup Menu	Next Dn
Diagnostics and History	Up Dn

Controller Programming and Operation

PROGRAMMING QUICK REFERENCE

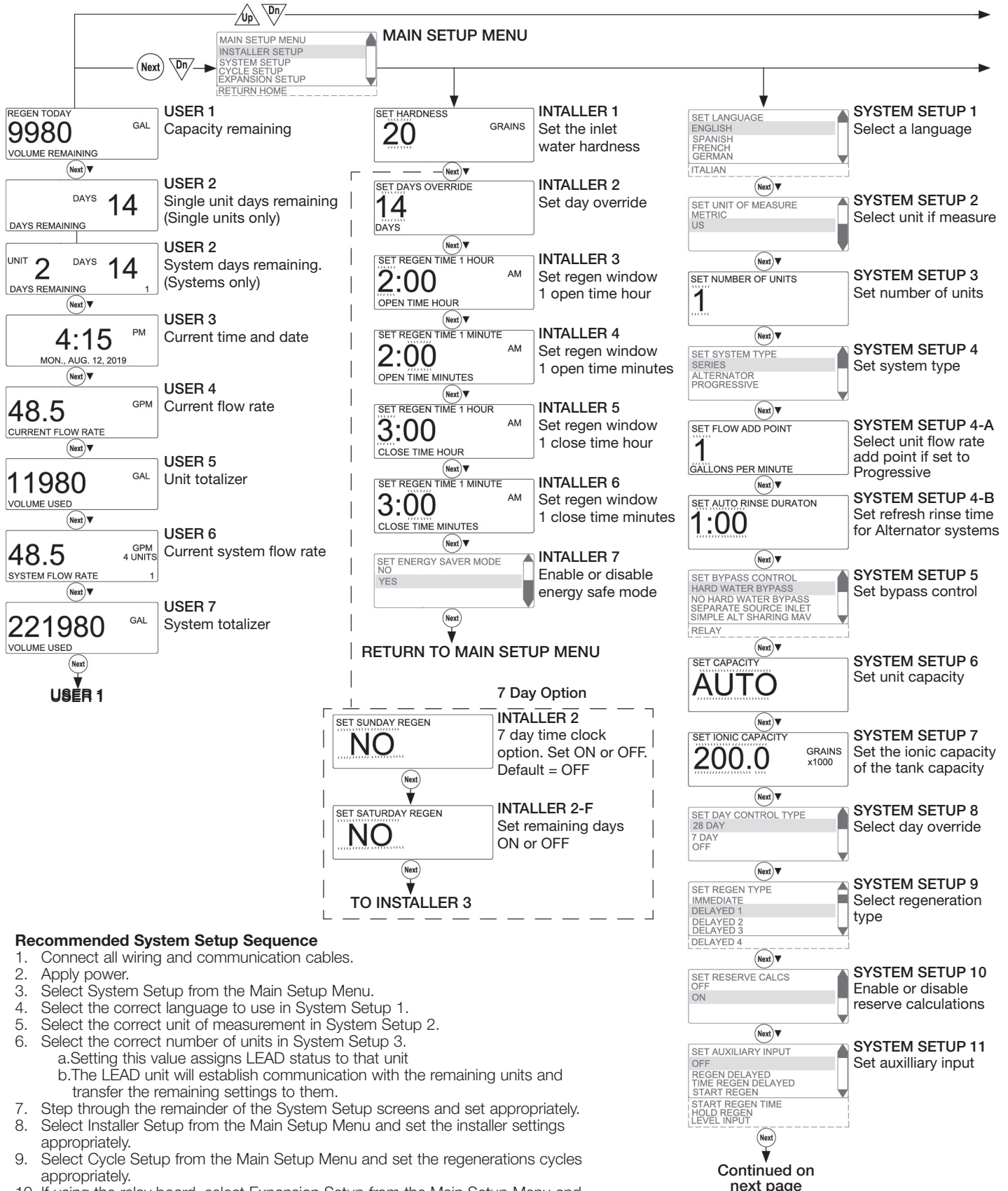

Recommended System Setup Sequence

1. Connect all wiring and communication cables.
2. Apply power.
3. Select System Setup from the Main Setup Menu.
4. Select the correct language to use in System Setup 1.
5. Select the correct unit of measurement in System Setup 2.
6. Select the correct number of units in System Setup 3.
 - a. Setting this value assigns LEAD status to that unit
 - b. The LEAD unit will establish communication with the remaining units and transfer the remaining settings to them.
7. Step through the remainder of the System Setup screens and set appropriately.
8. Select Installer Setup from the Main Setup Menu and set the installer settings appropriately.
9. Select Cycle Setup from the Main Setup Menu and set the regenerations cycles appropriately.
10. If using the relay board, select Expansion Setup from the Main Setup Menu and set the relays as needed.

CWS-300H Programming Screen Quick Reference

1. Individual screen descriptions and settings are detailed on the following pages.
2. Some screens have been omitted for clarity.

Controller Programming and Operation

PROGRAMMING QUICK REFERENCE



CYCLE SETUP 1-A
Select the first step of the primary cycle

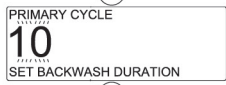

CYCLE SETUP 1-B
Set the duration for the first backwash of the primary cycle



CYCLE SETUP 1-C
Select last step of the primary cycle (9 steps max)



CYCLE SETUP 2
Enable or disable the secondary cycle



CYCLE SETUP 3-A
Select the first step of the secondary cycle

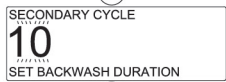

CYCLE SETUP 3-B
Set the duration for the first backwash of the secondary

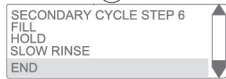

CYCLE SETUP 3-C
Select last step of the secondary cycle (9 steps max)

Return to main setup page

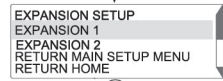

EXPANSION SETUP 1
Using UP or DOWN, select the expansion port to set up. Use SET CLOCK to return to main menu

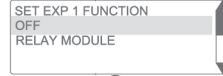

EXPANSION SETUP 2
Select expansion option

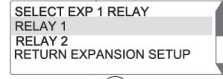

EXPANSION SETUP 3
Using UP or DOWN, select the relay to set and press NEXT. Use REGEN to return to the previous menu

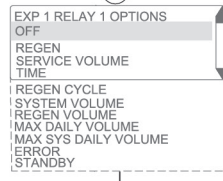

EXPANSION SETUP 4-A
Select the relay function for Relay 1

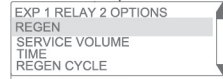

EXPANSION SETUP 4-B
Select the relay function for Relay 2

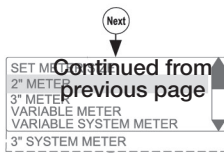

SYSTEM SETUP 12
Select meter type

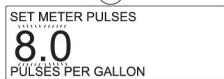

SYSTEM SETUP 12-A
Select meter pulse for variable meter types

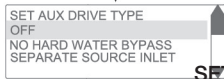

SYSTEM SETUP 13
See auxiliary drive type

Return to main setup menu

Controller Programming and Operation

PROGRAMMING QUICK REFERENCE

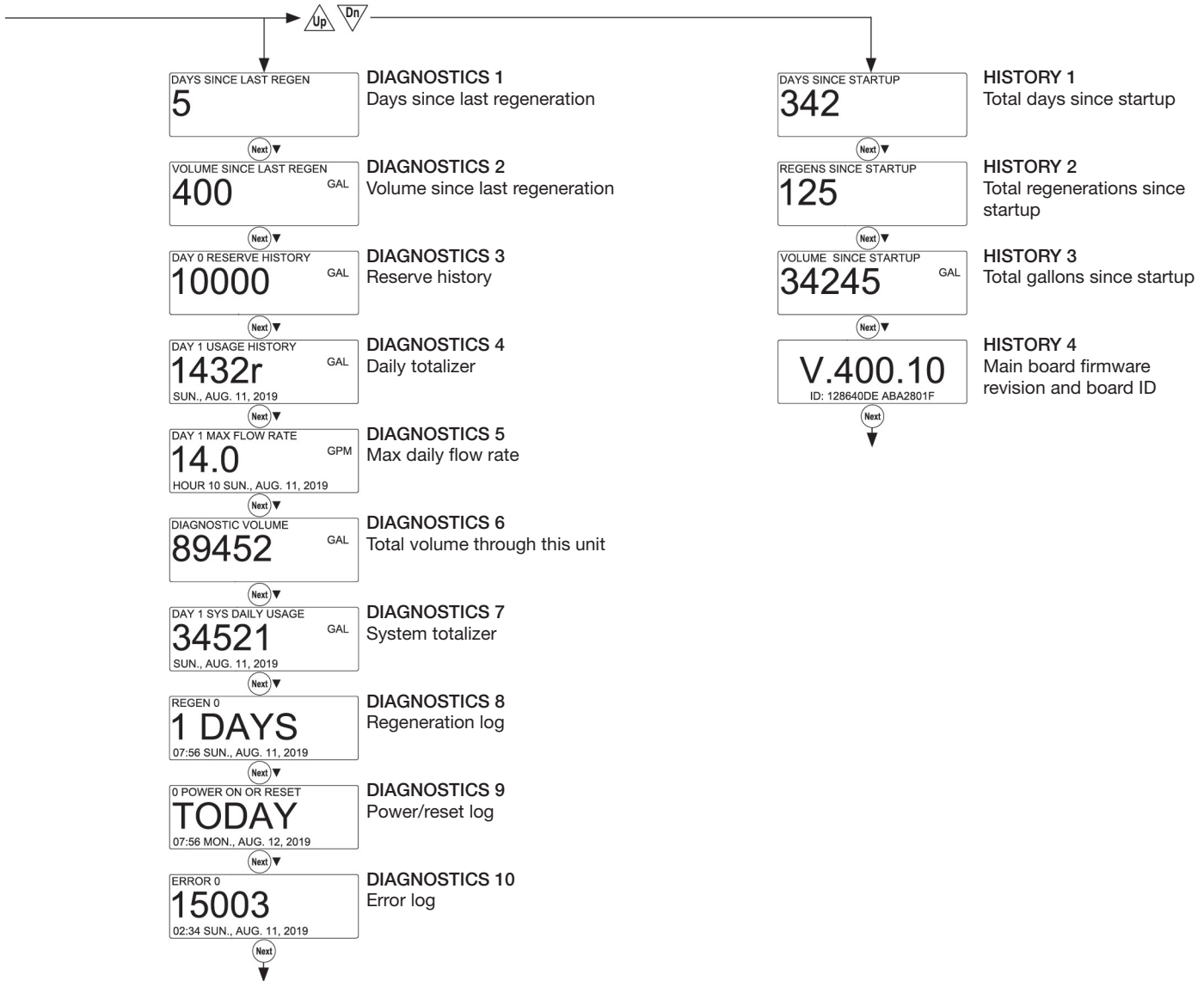

List of error codes:

CODE	DESCRIPTION
1001	No Encoder Pulses
1002	Unexpected Stall, Main Drive
1003	Run Time Too Long, Main Drive
14001	Message Queue Full
15003	Run Time Too Long, Bypass Drive
15010	Run Time Too Long, Bypass Drive Could Not Drive Offline
15011	Run Time Too Short, Bypass Drive Could Not Drive Online
16001	Communication Lost With Unit 2
16002	Communication Lost With Unit 3
16003	Communication Lost With Unit 4
18000	Reset Performed
18001	Power Loss
18002	Power Restored
20001	Run Time Too Long, AUX Drives
20002	Run Time Too Short During Unwind, AUX Drive
20011	Run Time Too Short, AUX Drive
21xxx	System Recovery From Memory Error

Controller Programming and Operation

TYPICAL USER SCREENS

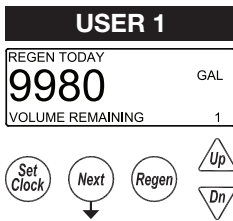

USER 1 - Capacity Remaining

- Displays the unit's current capacity remaining
- This screen does not display on units with volumetric capacity turned off
- Can be manually reduced by holding the down arrow

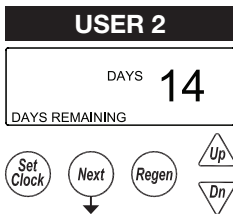

USER 2 - Days Remaining, Single Unit

- Displays a single unit's days until a regeneration, based on the day override setting
- This screen does not display on units with day override turned off
- On systems, the LEAD unit displays the days remaining
- Days can be manually reduced by holding the down arrow

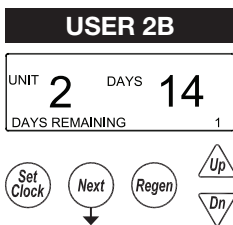

USER 2B - Days Remaining, System

- The LEAD in a system displays the days until a regeneration, based on the day override settings.
- The displays also indicates which unit the day override is currently pertaining to
 - Series regen systems do not display a unit as they will regenerate all units sequentially

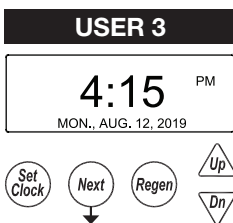

USER 3 - Time

- Displays the current date and time of day

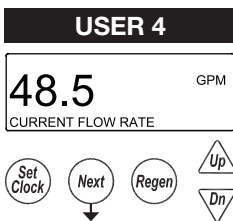

USER 4 - Flow Rate, Unit

- Displays that unit's current flow rate

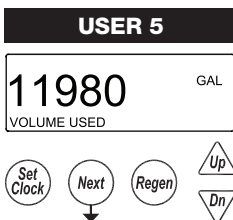

USER 5 - Volume Totalizer, Unit

- Displays the total volume since install / reset
- Resettable to zero, while in this screen, by holding the "Set Clock" & "Regen" buttons

Controller Programming and Operation

TYPICAL USER SCREENS (CONTINUED)

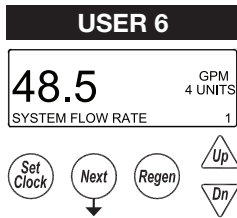

USER 6 – Flow Rate, System

- Displays the current combined flow rate of all the units in the system
- This screen does not display on single tank units or systems with volumetric capacity turned off

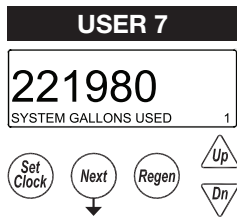

USER 7 – Volume Totalizer, System

- Displays the total volume of the system since install / reset
- Resetable to zero, while in this screen, by holding the “Set Clock” & “Regen” buttons
- This screen does not display on single tank units

TO USER 1

Controller Programming and Operation

SETTING TIME OF DAY AND DATE

SET TIME AND DATE
 Accessed by pressing Set Clock while in the User Screens. Use UP or DOWN arrows to scroll through the available settings.

RETURN TO NORMAL OPERATION

NOTIFICATIONS

REGEN TODAY
9980 GAL
 VOLUME REMAINING 1

DP REGENERATION HOLD
48.5 GPM
 CURRENT FLOW RATE

STANDBY ON LINE REGEN
HIGH VOLUME ERROR

STANDBY ON LINE REGEN
CHECK UNIT 4 ERROR

STANDBY ON LINE REGEN
ERROR 1003 ERROR

- REGEN TODAY**
 - Flashing indicates a regeneration has been manually set and can be turned off by pressing and releasing the REGEN button
 - A solid display indicates the regeneration has been scheduled by input requirements and can't be manually turned off
- REGENERATION HOLD / REGENERATION START**
 - The display will flash "DP REGENERATION HOLD" or "DP REGENERATION START", depending on settings, to indicate an external switch closure to the Aux. Input
- HIGH VOLUME**
 - Screen flashes indicating setpoint was reached when using relay outputs to signal high water usage. All LED lights flash and the relay with that setpoint closes.
 - Screen and the relay are reset by pressing any button
 - System operates as normal behind the indicator screen.
 - Only active if Timer 2 or Timer 3 is set to "Day & Gal" or "Day & Gal & System"

ERRORS

- NUMBER OF UNITS ERROR**
 - The LEAD unit of a system would flash an error screen alerting of a loss of communication with a unit
 - Check for proper operation and connectivity of the unit specified as lost communications
 - Pressing any button will return the user to the # units set up screen to correct / verify the value of units in the system. Exiting will re-establish communications
 - Each unit of the system will regenerate, based on its settings, with hard water bypass
- FUNCTIONAL ERROR**
 - "Error" and its code will flash on the display with a red backlight
 - The unit attempts to return to service but will not regenerate until the error is cleared
 - See troubleshooting section for a description of possible error codes.

Controller Programming and Operation

MAIN MENU SCREEN

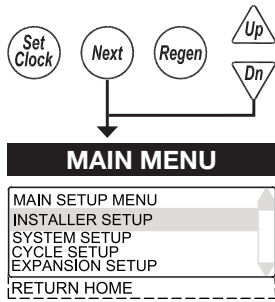

Accessed by pressing NEXT and DOWN simultaneously for >3 seconds while in one of the user screens.

INSTALLER SETUP - Setup items under the Installer Setup Screens section

SYSTEM SETUP - Setup items in the System Setup Screens section

CYCLE SETUP - Setup the primary and secondary regeneration cycles

EXPANSION SETUP - Setup expansion port options if expansion boards are installed

RETURN HOME - Return back to the user screens

- Once you are in any of the submenus, use the REGEN button to back out to the Main Menu
- The SET CLOCK button will typically exit from any menu and return to the user screens

Controller Programming and Operation

SYSTEM SETUP SCREENS

Accessed by pressing NEXT and DOWN simultaneously for >3 seconds and selecting SYSTEM SETUP from the Main Menu. On multi-unit systems, only program the main valve number one or the LEAD unit.

- System setup screens will be locked on units determined to be a LAG of a system
 - LAG units need to be reset, "Next" & "Regen" from any screen to have their LAG status turned off.

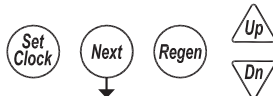
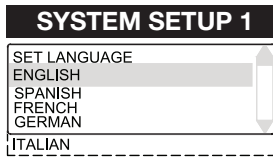

SYSTEM SETUP 1 – Select language

Select one of the available languages to be used when displaying text on the display.

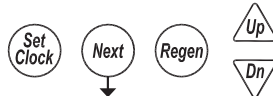
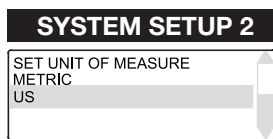

SYSTEM SETUP 2 - Set unit of measure

Select either Metric units or US units for measurements.

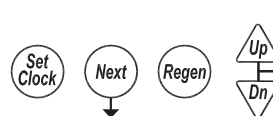
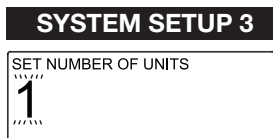

SYSTEM SETUP 3 - Set number of units

Up to 16 units can be daisy chained using the communication in and out ports on the controls.

SYSTEM SETUP 3A - Enable or disable Modbus

Enable or disable the Modbus communication protocol.

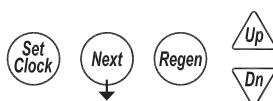
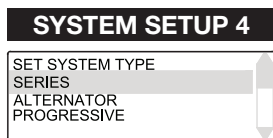
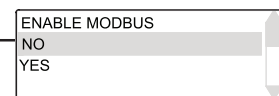

SYSTEM SETUP 4 – Select System Type / Operation

This screen is only available if the number of units selected is greater than 1.

Series: All units are always online unless they are regenerating.

- Units in a series flow system will determine the need to regenerate based on:
 - Any one unit reaching 0 capacity
 - Day override
 - Any one unit's need to regenerate will initiate sequential regenerations of all units (series regeneration)
 - Immediate systems will regenerate all units in series upon the first unit reaching 0 capacity
 - Delayed units will regenerate during one or more of the delayed regeneration windows
- Alternator: Operates the system as an alternator, having one unit off-line at all times either regenerating or fully regenerated.**
- A unit in an alternator system will determine the need to regenerate based on:
 - The current LEAD unit reaching 0 capacity
 - Immediate systems immediately regenerate and alternate the exhausted unit with a fully regenerated standby unit.
 - Delayed systems will immediately alternate the exhausted unit with a fully regenerated standby unit, and regenerate at the next available time slot.
 - LEAD unit regenerates based on LAG units
 - The first LAG unit depleting down to 15% less than its ratio of system capacity
 - 1/3 for a 4 unit; 1/2 for a 3 unit
 - The second LAG unit depleting down to 15% less than its ratio of system capacity
 - 2/3 for a 4 unit

Controller Programming and Operation

SYSTEM SETUP SCREENS (CONTINUED)

- Delayed systems will flag LEAD units based on LAG capacity, but will not alternate with remaining capacity until the next available delayed time.
- Day override
 - 1 day; 1 unit will regen
 - Day triggered regens will run at the time set for the first regeneration window
- Progressive (Demand Recall):** one unit is always online & additional units are added as the online units exceed the flow add point.
 - Additional units are brought online when:
 - The adder point is exceeded for 30 seconds
 - All required units required to cover the flow conditions will be brought into service immediately if the flow exceeds 120% of the adder point.
 - Units will go off-line when
 - System flow reduces to 95% of the set adder point / unit for 1 minute.
 - Any unit in a demand recall system will determine the need to regenerate based on:
 - Each unit individually reaching 0 capacity
 - Immediate systems will regenerate depleted units immediately after current flow conditions allow depleted units off-line.
 - Delayed units will alternate LEAD units immediately upon exhaustion and regenerate them at the next available time slot.
- Day Override
 - One unit will be regenerated per delayed time slot (i.e. a 4 unit system will need 4 delayed times to regenerate all units / set number of days).
 - Day triggered regens will run at the time set in the first regeneration window
- Units cannot regenerate if flow demands them to remain online
 - Immediate units regen immediately after flow allows them off-line
 - Delayed units regen at the next available time slot
 - Day units regen at the next time slot

SYSTEM SETUP 4A

SET FLOW ADD POINT
 1
 GALLONS PER MINUTE

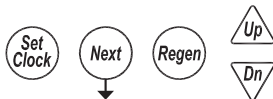

SYSTEM SETUP 4A - Set flow add point

- Only available on Progressive systems
- Sets the flow rate which controls the point at which more valves are brought online or taken off-line based on the flow rate

SYSTEM SETUP 4B

SET AUTO RINSE DURATION
 1:00

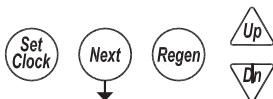

SYSTEM SETUP 4B - Set Pre-Service Rinse

- Only available on Alternator systems
- Standby units will run through a rinse cycle before coming into service

SYSTEM SETUP 5

SET ISOLATION TIMING
 HARD WATER BYPASS
 NO HARD WATER BYPASS
 SEPARATE SOURCE INLET
 SIMPLE ALT SHARING MAY
 RELAY

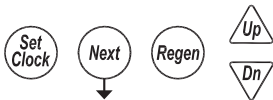

SYSTEM SETUP 5 - Select bypass control

- Selections allow enabling and timing control of motorized drive
- Selection availability can vary by the type of system
- Custom timing sequences can be configured under “Custom Motorized Drive Timing” at the end of the programming section

Hardwater Bypass

- Only available on single units
- Unit will internally bypass hard water to the service lines while in regeneration

No Hardwater Bypass

- Each unit has isolation to control system operation and will not supply service water during regeneration
- Drive timing will bring the unit into service during fill

Controller Programming and Operation

SYSTEM SETUP SCREENS (CONTINUED)

Separate Source

- Each unit has isolation to control system operation and will not supply service water during regeneration
- Drive timing will keep units isolated through the entire regeneration sequence

Simple Alt Sharing MAV

- Only available when set to a 2 unit alternator
- A “Simple 2 Unit” shares one MAV to be electrically connected to the bypass connection of the “B” (LAG) unit

Relay

- Only available when when the optional relay expansion module is installed and one or both of the relays is set for Standby
- Isolation will be done through the optional relay expansion module and does not initialize the BYPASS motorized drive circuit

Simple Alt Sharing MAV

- Only available when set to a 2 unit alternator
- A “Simple 2 Unit” shares one MAV to be electrically connected to the bypass connection of the “B” (LAG) unit

SYSTEM SETUP 6

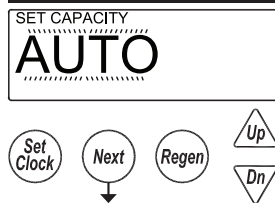

SYSTEM SETUP 6 – Set unit capacity

- Only available for US based measurements
- Allows for automatic calculation of tank capacity or user entered capacity

SYSTEM SETUP 7

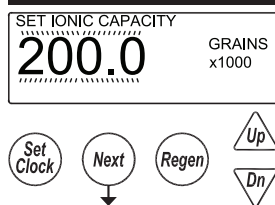

SYSTEM SETUP 7 - Set the ionic capacity of the tank

- Only available for US based measurements
- Used for auto-calculation of unit capacity

SYSTEM SETUP 8

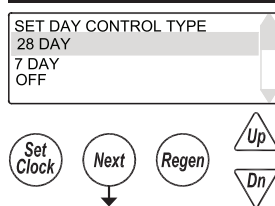

SYSTEM SETUP 8 - Day override control

- 28 day time clock: Used to regenerate units based on a set number of days between regenerations
- 7 Day Time Clock: Used to control regeneration based on specific days
- OFF: Days have no control on regenerations, and will not be a selection if volumetric capacity is set to OFF

Controller Programming and Operation

SYSTEM SETUP SCREENS (CONTINUED)

SYSTEM SETUP 9

SET REGEN TYPE
IMMEDIATE
DELAYED 1
DELAYED 2
DELAYED 3
DELAYED 4

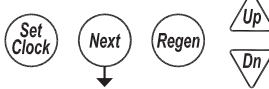

SYSTEM SETUP 9 - Regeneration control

Delayed 1 – 4

- Delays regeneration of units upon reaching 0 gallons capacity
- Allows setting of up to 4 regeneration windows per day
- Systems with delayed regen will remove a unit from service based upon 0 capacity and regenerate at the scheduled regen time.
 - Any unit needing regeneration while the window of time is available will be able to regenerate. Only one unit will regen at a time
 - Day driven regens will regen at the Delayed 1 window time
 - Depleted units will regen at the next available delayed time slot

Immediate-Immediate regeneration of units upon reaching 0 capacity

- Series regeneration systems set to Immediate will sequentially regenerate all units at the delayed time based on day override

SYSTEM SETUP 10

SET RESERVE CALCS
OFF
ON

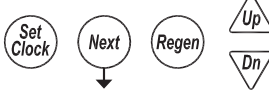

SYSTEM SETUP 10 – Automatic reserve calculation

This screen will not display on units set to Immediate, capacity set to Off, or any multi-unit systems

On: Unit will regenerate before reaching 0 capacity, based on previous usage trends

Requires delayed regeneration

OFF: Regeneration is scheduled after reaching 0 capacity

SYSTEM SETUP 11

SET AUXILIARY INPUT
OFF
REGEN DELAYED
TIME REGEN DELAYED
START REGEN
START REGEN TIME
HOLD REGEN
LEVEL INPUT

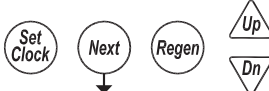

SYSTEM SETUP 11 - Auxiliary Input

OFF

- Auxiliary input is disabled

REGEN DELAYED

- Control will immediately schedule a regen upon switch closure
- Systems follow “Delayed Logic” regenerating flagged units in available time slots

TIME REGEN DELAYED

- Control will immediately schedule a regeneration upon accumulating 2 minutes of intermittent switch closures
- Systems follow “Delayed Logic” regenerating flagged units in available time slots

START REGEN

- Control will start an immediate regeneration upon switch closure
- Systems follow “Immediate logic” regenerating all flagged units sequentially

START REGEN TIME

- Control will immediately regenerate upon accumulating 2 minutes of intermittent switch
- Systems follow “Immediate logic” regenerating all flagged units sequentially

HOLD REGEN

- Regeneration will not be allowed as long as there is switch closure
 - On0 units will regenerate immediately after the hold switch opens
 - Delayed regenerations will be delayed until the next scheduled time if the hold is active when the scheduled time passes

LEVEL INPUT

- Only available on single units
- External switching can be used to control the Online/Standby status
 - Switch closure will trigger the unit to go to a standby condition

Controller Programming and Operation

SYSTEM SETUP SCREENS (CONTINUED)

SYSTEM SETUP 11A

SET METER PULSES
8.0
PULSES PER GALLON

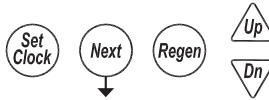

SYSTEM SETUP 11A - Level Input option selected

Set a time duration of switch closure when Level option is selected

SYSTEM SETUP 12

SET METER SIZE
2" METER
3" METER
VARIABLE METER
VARIABLE SYSTEM METER
3" SYSTEM METER

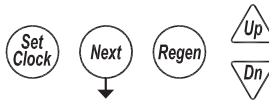

SYSTEM SETUP 12 - Meter Size Selection

2" METER: Setting for using a factory 2" meter

3" METER: Setting for using a factory 3" meter

VARIABLE METER: Used to set meter input off custom pulse rate, typically for non-factory meters

VARIABLE SYSTEM METER: Only available on 2 unit alternators. The system shares 1 external meter which is connected to the LAG unit's meter connection.

3" SYSTEM METER: Only available on 2 unit alternators. The system shares 1 external meter which is connected to the LAG unit's meter connection.

SYSTEM SETUP 12A

SET METER PULSES
8.0
PULSES PER GALLON

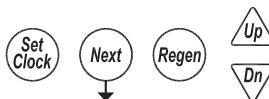

SYSTEM SETUP 12A - Set Meter Pulses / Gallon

-Only displays if "VARIABLE METER" or "VARIABLE SYSTEM METER" is selected in the previous screen

-Set to the desired pulse rate of the installed metering device

SYSTEM SETUP 13

SET AUX DRIVE TYPE
OFF
NO HARD WATER BYPASS
SEPARATE SOURCE INLET

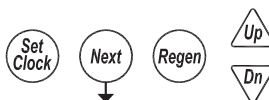

SYSTEM SETUP 13- Auxiliary Drive

- Selections allow enabling and timing control of the Auxilliary motorized drive circuit
- Requires a factory motorized drive to be connected to the AUX DRIVE connector
- Custom timing sequences can be configured under "Custom Motorized Drive Timing" at the end of the programming section

Off

- The auxiliary drive output is disabled

No Hard Water Bypass

- Each unit has isolation to control system operation and will not supply service water during regeneration
- Drive timing will bring the unit into service during fill

Separate Source

- Each unit has isolation to control system operation and will not supply service water during regeneration
- Drive timing will keep units isolated through the entire regeneration sequence

Controller Programming and Operation

CYCLE SETUP SCREENS

Accessed by pressing NEXT and DOWN simultaneously for >3 seconds and selecting CYCLE SETUP from the Main Menu.

CYCLE SETUP 1A

SET CYCLE 1 STEP 1
BACKWASH
RINSE
DRAW
FILL
HOLD
SLOW RINSE
END

CYCLE SETUP 1A

Select first step of the primary regeneration cycle.

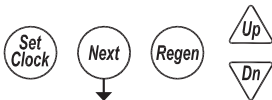

CYCLE SETUP 1B

PRIMARY CYCLE
10
SET BACKWASH DURATION

CYCLE SETUP 1B

Select the time of duration for the first step of the primary regeneration cycle.

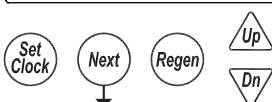

CYCLE SETUP 1C

PRIMARY CYCLE STEP 6
FILL
HOLD
SLOW RINSE
END

CYCLE SETUP 1C

Select the second step of the primary regeneration cycle.

Continue selecting the step type and entering the duration until the primary regeneration cycle has been defined.

Select END as the last step of the primary regeneration cycle.

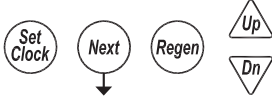

CYCLE SETUP 2

SET REGEN REPEATS
OFF

CYCLE SETUP 2

Select regeneration repeats, 1-9 or OFF.

Repeats the primary regeneration cycle a selected number of times before regenerating a single time with the secondary regeneration cycle.

The following screens will not appear if regeneration repeats is set to OFF.



CYCLE SETUP 3A

SET CYCLE 2 STEP 1
BACKWASH
RINSE
DRAW
FILL
HOLD
SLOW RINSE
END

CYCLE SETUP 3A

Select first step of the secondary regeneration cycle.

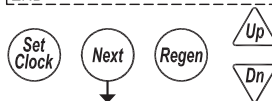

CYCLE SETUP 3B

SET CYCLE 2 DURATION
10
SET BACKWASH DURATION

CYCLE SETUP 3B

Select the time of duration for the first step of the secondary regeneration cycle.

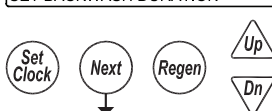

Controller Programming and Operation

CYCLE SETUP SCREENS (CONTINUED)

CYCLE SETUP 3C

SECONDARY CYCLE STEP 6
FILL
HOLD
SLOW RINSE
END

CYCLE SETUP 3C

Select the second step of the secondary regeneration cycle.

Continue selecting the step type and entering the duration until the secondary regeneration cycle has been defined.

Select END as the last step of the secondary regeneration cycle.

Set
Clock

Next

Regen

Up
Dn

RETURN TO MAIN
MENU

Controller Programming and Operation

EXPANSION SETUP SCREENS

Accessed by pressing NEXT and DOWN simultaneously for >3 seconds and selecting EXPANSION SETUP from the Main Menu.

EXPANSION SETUP 1

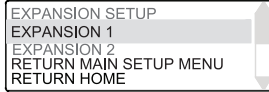

EXPANSION SETUP 1

Select the expansion port, 1 or 2, that you will modify.

EXPANSION SETUP 2

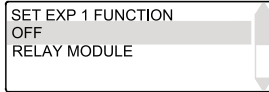

EXPANSION SETUP 2

Select the installed expansion board or OFF if no expansion board is installed.

EXPANSION SETUP 2A

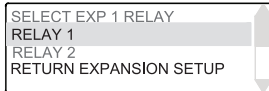

EXPANSION SETUP 2A

If RELAY MODULE was selected from Expansion Setup 2, select which relay to modify.

EXPANSION SETUP 2B

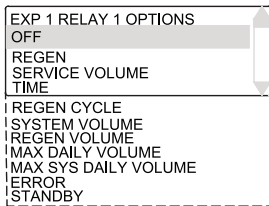

EXPANSION SETUP 2B

Select how the relay should function or OFF if the relay will not be used.

OFF - Relay is not used

REGEN - The relay is energized while the control is regenerating

SERVICE VOLUME - The relay is energized, during service only, every specified amount of volume used and for a specified amount of time

TIME - The relay is energized based on a set amount of time after the start of regeneration and will stay energized for a specified amount of time

REGEN CYCLE - The relay is energized based on the start of a specified cycle and will stay energized for a specified amount of time

SYSTEM VOLUME - The relay is energized, at a specified volume, based on combined volume usage of all units in the system and stays energized for a specified time. Only available on the LEAD unit of a system.

REGEN VOLUME - The relay is energized, during service & while in regen, every specified amount of service flow and for a specified amount of time

MAX DAILY VOLUME - The relay is energized, based on a units usage, at a specified daily volume to signal a usage alarm. "HIGH VOLUME ERROR" flashes on the screen while unit continues to operate as normal. Pressing any button resets the relay and returns the unit to the user screens.

MAX SYS DAILY VOLUME - The relay is energized, at a specified amount, based on combined volume usage of all units in the system. "HIGH VOLUME ERROR" flashes on the screen while unit continues to operate as normal. Pressing any button resets the relay and returns the unit to the user screens. Only available on the LEAD unit of a system

ERROR - The relay is energized to signal an error condition

STANDBY - The relay is energized based on the unit's Standby status. Relays could be used to control external valving or signaling a unit's Online status.

Controller Programming and Operation

EXPANSION SETUP SCREENS (CONTINUED)

EXPANSION SETUP 2B-1A

SET EXP 1 RLY 1 VOLUME
20 GAL
SERVICE VOLUME

EXPANSION SETUP 2B-1A SERVICE VOLUME

- Enter the volume at which the relay should energize

EXPANSION SETUP 2B-1B

SET EXP 1 RLY 1 ON TIME
3:00
RELAY ON TIME

EXPANSION SETUP 2B-1B SERVICE VOLUME

- Enter the total time to keep the relay energized

EXPANSION SETUP 2B-2A

SET EXP 1 RLY 1 DLY TIME
10:00
RELAY START DELAY

EXPANSION SETUP 2B-2A TIME

- Enter the delay time, after regeneration starts, before energizing the relay

EXPANSION SETUP 2B-2B

SET EXP 1 RLY 1 ON TIME
3:00
RELAY ON TIME

EXPANSION SETUP 2B-2B TIME

- Enter the total time to keep the relay energized

EXPANSION SETUP 2B-3A

SET RELAY 1 CYCLE
BACKWASH
RINSE
DRAW
FILL
HOLD
SLOW RINSE

EXPANSION SETUP 2B-3A REGEN CYCLE

- Select the regeneration cycle to energize the relay

EXPANSION SETUP 2B-3B

SET EXP 1 RLY 1 ON TIME
3:00
RELAY ON TIME

EXPANSION SETUP 2B-3B REGEN CYCLE

- Enter the total time to keep the relay energized

EXPANSION SETUP 2B-4A

SET EXP 1 RLY 1 VOLUME
20 GAL
SYSTEM VOLUME

EXPANSION SETUP 2B-4A SYSTEM VOLUME

- Enter the volume at which the relay should energize

EXPANSION SETUP 2B-4B

SET EXP 1 RLY 1 ON TIME
3:00
RELAY ON TIME

EXPANSION SETUP 2B-4B SYSTEM VOLUME

- Enter the total time to keep the relay energized

Controller Programming and Operation

EXPANSION SETUP SCREENS (CONTINUED)

EXPANSION SETUP 2B-5A

SET EXP 1 RLY 1 VOLUME
20 GAL
REGEN VOLUME

EXPANSION SETUP 2B-5A REGEN VOLUME

- Enter the volume at which the relay should energize

EXPANSION SETUP 2B-5B

SET EXP 1 RLY 1 ON TIME
3:00
RELAY ON TIME

EXPANSION SETUP 2B-5B REGEN VOLUME

- Enter the total time to keep the relay energized

EXPANSION SETUP 2B-6A

SET EXP 1 RLY 1 VOLUME
20 GAL
MAX DAILY VOLUME

EXPANSION SETUP 2B-6A MAX DAILY VOLUME

- Enter the volume at which the relay should energize

EXPANSION SETUP 2B-7A

SET EXP 1 RLY 1 VOLUME
20 GAL
MAX SYS DAILY VOLUME

EXPANSION SETUP 2B-7A MAX SYS DAILY VOLUME

- Enter the volume at which the relay should energize

Controller Programming and Operation

INSTALLER SETUP SCREENS

Accessed by pressing NEXT and DOWN simultaneously for >3 seconds and selecting INSTALLER SETUP from the Main Menu.

INSTALLER 1

SET HARDNESS
20
GRAINS

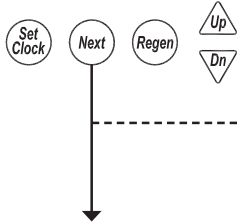

INSTALLER 1 – Set hardness

Set the inlet water hardness, in grains.

- This screen is only available if set to US units of measurement.
- This screen is not available if System Setup 6 is set to OFF.

Set current day and regen days when set as a 7 day time clock in System Setup 8. See next page.

INSTALLER 2

SET DAYS OVERRIDE
14
DAYS

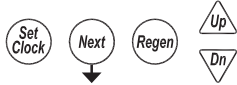

INSTALLER 2 – Set Days Between Regenerations (Day override)

Set day override. 1-28 days between regenerations, or if set to 7 day time clock, see 7 day setup on next page. OFF will only be displayed if “OFF” is selected in System Setup 8.

- Settings will be based on the type of day override control set in system setup.
- Off will be displayed for units with day override turned off

1 – 28: When set as a 28 day override

- Set the days between regens

1 – 7: When set as a 7 day timeclock

- Turn regen on or off for each specific day of the week, Sunday - Saturday

INSTALLER 3

SET REGEN TIME 1 HOUR
2:00
AM
OPEN TIME HOUR

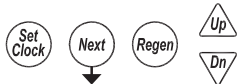

INSTALLER 3 – Set Delayed Regeneration Open Time Hour

• A maximum of 4 regeneration windows can be set up. Set up the open time (hour:minute) and close time (hour:minute) for each window.

- Set the delayed time of regeneration, hour (AM / PM toggles at midnight)

INSTALLER 4

SET REGEN TIME 1 MINUTE
2:00
AM
OPEN TIME MINUTES

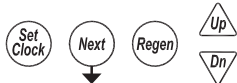

INSTALLER 4 – Set Delayed Regeneration Open Time Minute

- Set delayed time of regeneration, minute

INSTALLER 5

SET REGEN TIME 1 HOUR
3:00
AM
CLOSE TIME HOUR

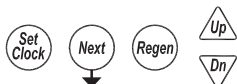

INSTALLER 5 – Set Delayed Regeneration Close Time Hour

- Set the delayed time of regeneration, hour (AM / PM toggles at midnight)

Controller Programming and Operation

INSTALLER SETUP SCREENS (CONTINUED)

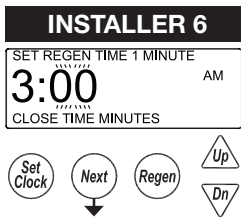

INSTALLER 6 – Set Delayed Regeneration Close Time Minute

- Set delayed time of regeneration, minute
- When configured for multiple delayed regeneration windows, repeat Installer steps 3 through 6 for each additional window

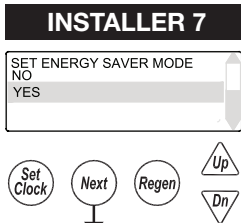

INSTALLER 7 – Set Energy Saver Mode

- When enabled, the backlight will turn off after five minutes of no flow and no button presses

**RETURN TO NORMAL
OPERATION**

7 DAY OPTION

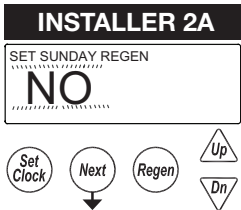

INSTALLER 2A

- Use UP or DOWN to toggle between YES or NO to control regeneration for each day
- Press NEXT to advance to the next day
- Repeat for each day of the week
(e.g., no regeneration on Sunday)

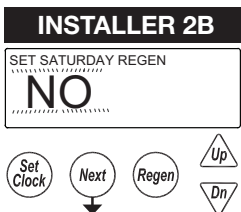

INSTALLER 2B

- Use UP or DOWN to toggle between YES or NO
(e.g., regeneration on Saturday)

INSTALLER 3
(see previous page)

Controller Programming and Operation

DIAGNOSTIC SCREENS

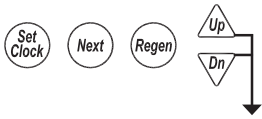

Accessed by pressing UP and DOWN simultaneously for >3 seconds.

DIAGNOSTIC 1

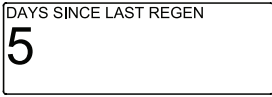

DIAGNOSTIC 1

Days since the last regeneration.

All Diagnostic History screens are resettable with the History Reset sequence while in the Diagnostics 1 screen. Holding the Set Clock and Regen buttons for > 3 seconds initiates a totalizer or history reset.

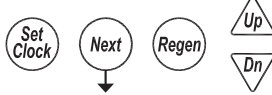

DIAGNOSTIC 2



DIAGNOSTIC 2

Volume since the last regeneration.

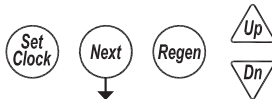

DIAGNOSTIC 3



DIAGNOSTIC 3

- Displays the reserve history
- Does not display on systems or units with reserve set to OFF
- Use the UP & DN arrows to scroll through each day's history
 - Day 0 is today's reserve (tomorrow's anticipated usage)
 - 1 was yesterday's reserve (today's anticipated usage)

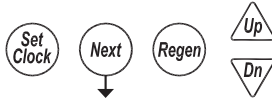

DIAGNOSTIC 4



DIAGNOSTIC 4

History of volume used.

Use UP and DOWN arrows to select a day.

0 = Today

1 = Yesterday

127 = 127 days ago (max.)

Simultaneously press UP and DOWN.

An "r" will be displayed after the volume amount if a regeneration occurred that day.

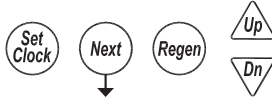

Controller Programming and Operation

DIAGNOSTIC SCREENS (CONTINUED)

DIAGNOSTIC 4A

DIAGNOSTIC 4A

Hourly history of volume use. Use the UP and DOWN arrow to select the hours of the day.



Returns user back to USE Day 0 in Diagnostic 4 screen.

DIAGNOSTIC 5

DIAGNOSTICS 5

- Displays the max flow rate and the hour it occurred
- Use the UP & DN arrows to scroll through 128 days history
 - Day 0 is today
 - Day 1 was yesterday

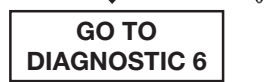
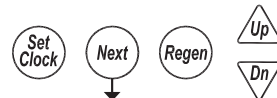
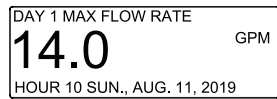

Simultaneously press UP and DOWN.

DIAGNOSTIC 5A

DIAGNOSTICS 5A

Hourly history of maximum flow rate. Use the UP and DOWN arrows to select the hours of the day from screen 5.

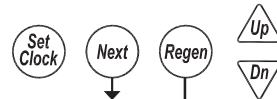
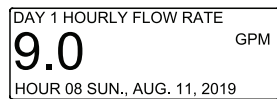

Returns user back to USE Day 0 in Diagnostic 5 screen.

DIAGNOSTIC 6

DIAGNOSTIC 6

Total volume through the unit.

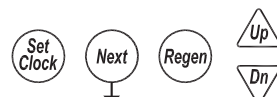

DIAGNOSTIC 7

DIAGNOSTICS 7

Total system history of volume used. Use UP and DOWN arrows to select a day.

- 0 = Today
- 1 = Yesterday
- 127 = 127 days ago (max.)

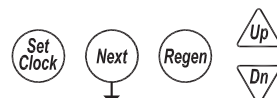

Simultaneously press UP and DOWN.



Controller Programming and Operation

DIAGNOSTIC SCREENS (CONTINUED)

DIAGNOSTIC 7A

DAY 1 SYS HOURLY USAGE GAL
1340
HOOR 02 SUN., AUG. 11, 2019

DIAGNOSTICS 7A

Total system hourly history of volume. Use UP and DOWN arrows to select the hours of the day from Screen 7.

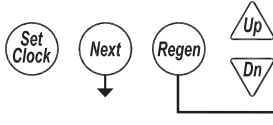

Returns user back to USE Day 0 in Diagnostic 7 screen.

DIAGNOSTIC 8

REGEN 0
1 DAYS
07:56 SUN., AUG. 11, 2019

DIAGNOSTICS 8

- Displays the time and day of the last 40 regenerations
- Use the UP and DOWN arrows to scroll through each saved regeneration

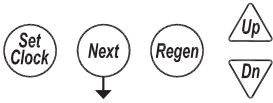

DIAGNOSTIC 9

0 POWER ON OR RESET
TODAY
07:56 MON., AUG. 12, 2019

DIAGNOSTICS 9

- Displays the time and day of the last 20 power-up/resets
- Use the UP and DOWN arrows to scroll through each saved power-up/reset

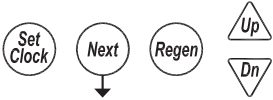

DIAGNOSTIC 10

ERROR 0
15003
02:34 SUN., AUG. 11, 2019

DIAGNOSTICS 10

- Displays the time and day of the last 20 errors
- Use the UP and DOWN arrows to scroll through each saved error

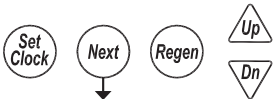

RETURN TO USER
SCREEN

Controller Programming and Operation

VALVE HISTORY

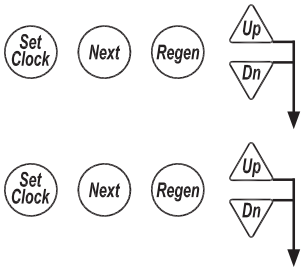

Accessed by pressing UP and DOWN simultaneously for >3 seconds, then by pressing UP and DOWN simultaneously again for >3 seconds. Non-Resettable



HISTORY 1

Total days since startup.
Time only accumulates while the unit is plugged in.

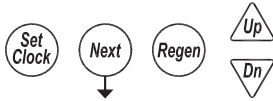

HISTORY 2

Total regenerations since startup.

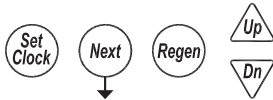

HISTORY 3

Total volume treated since startup.

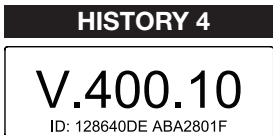
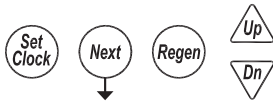

HISTORY 4

Main board software

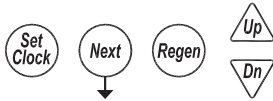

**RETURN TO NORMAL
OPERATION**

Controller Programming and Operation

CUSTOM MOTORIZED DRIVE TIMING

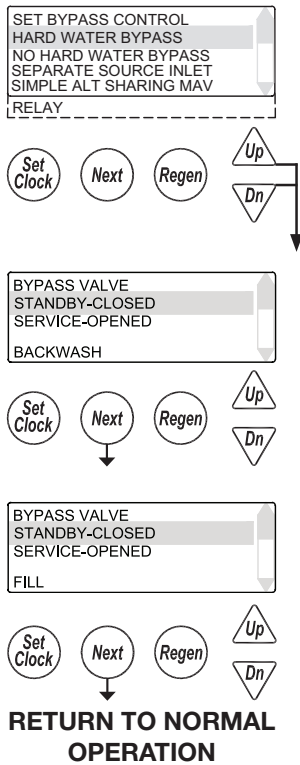

- Used to alter the standard timing sequence of the motorized isolation valve for complete custom timing of the drive circuits
 - Setup procedure applies to both the “Bypass” drive and “Aux” drive
- Customization needs to be done after defining the regeneration cycle sequence
- Accessed by pressing the UP and DOWN arrows simultaneously while in the No Hard Water Bypass selection
 - Next will scroll through each cycle of the regeneration program
 - Arrow buttons toggle Standby and Online indicating the desired position of the drive during that cycle of the regeneration.
 - In the example screens, the “Bypass” drive will be transitioning off-line for Backwash (Cycle 1) and coming online for Fill (Cycle 5).

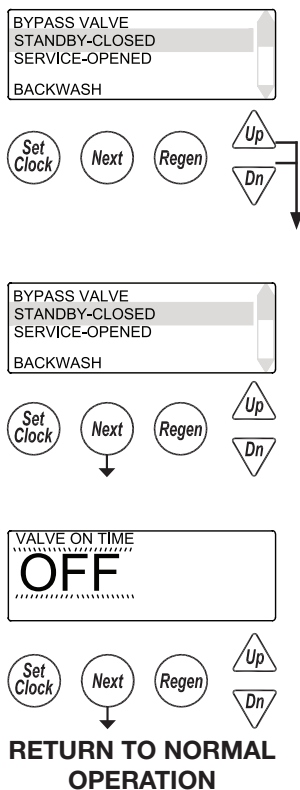

- Timing can be further customized per cycle by adding a time delay to the sequence
 - Accessed by pressing the UP and DOWN arrows simultaneously while in the drive sequence screens
 - Setting a “Start Time” delays the start of that transition after reaching set cycle
 - A second time screen then sets the time the drive maintains that set position before transitioning back to its previous position.
 - “Regen” will be illuminated to identify that a sequence has a time modifier associated with it
 - In the example screens, the “Bypass” drive will delay its transition to off-line until 2 minutes into Backwash (Cycle 1) and coming online for Fill (Cycle 5).

Replacing the Media

NOTICE

Ion exchange resin may need to be replaced periodically due to physical breakdown caused by chlorine/chloramine disinfectants, or fouling caused by certain metals such as iron and manganese.

1. Mark the location of the mineral tanks on the floor incase they need to be moved once all water, resin and gravel has been removed. This will help with realignment of the plumbing after media replacement. DO NOT attempt to move a mineral tank that contains media and or water.
 2. Open the bypass valve.
 3. Close the inlet and outlet isolation valves for the mineral tank needing media replacement
 4. Press and hold Regen button for >3 sec to manually start the regen cycle, place the system in the backwash position. This relieves any pressure inside the mineral tank. Once the system cycles into the backwash position, unplug the control valve from the power outlet to keep the system in the backwash position.
 5. Disconnect the inlet, outlet, and drain union plumbing fittings. Then, if necessary for the removal of the control valve from the mineral tank, remove the remaining plumbing from the inlet, outlet and drain ports of the control valve.
 6. Disconnect the meter cable from the meter and from the Flow meter port located on the back of the control valve controller. Store the meter cable in a safe location.
 7. Disconnect the brine tubing from the control valve's brine connection port.
 8. Disconnect the power supply cable from the power supply port located on the side of the control board.
 9. If this is an CWSP-200HF series system disconnect any inter-connecting communication cables from the COMM IN and COMM OUT ports located on the TOP of the control board.
 10. Remove the control valve from the mineral tank by turning the control valve counter-clockwise when viewed from above. Keeping a firm grip on the control valve, continue to rotate until it can be lifted off of the top of the mineral tank. Store the control valve in a safe location.
 11. Note the top of the distributor tube. It must be flush with the top of the tank. If it is above the top of the tank by more than $\frac{1}{2}$ " the distributor tube may have become disconnected from the distributor screen in the bottom of the mineral and must be reconnected.
 12. Obtain a length of $\frac{3}{4}$ " sch. 40 PVC that is the same height as the mineral tank and a length of 1" clear braided poly-vinyl hose. The hose must be long enough to reach the nearest floor drain. (Both of these can be acquired at a local hardware store).
 13. Insert one end of the pipe inside the hose and the other end of the pipe into the top of the mineral tank and down into the resin media. Put the other end of the hose inside a water permeable bag and locate the bag over the floor drain.
 14. Insert a garden hose into the bag side of the poly-vinyl hose to fill the hose and PVC pipe with water. Air will bubble out of the tank. Once all the air is out of the hose and pipe, remove the garden hose from the polyvinyl hose to establish a siphon. The resin can then be siphoned into the bag. Use the garden hose to maintain a full water level in the mineral tank to. The bag end of the poly-vinyl hose must remain lower in elevation than the end of the PVC pipe in the mineral tank to maintain the siphon. The bag will retain the resin while the water flows down the drain. Use caution not to allow resin to enter the floor drain.
 15. Continue to siphon resin until it is completely evacuated from the mineral tank. Gravel will clogged the siphon hose and, if it must be removed due to fouling, or to repair or replace a damaged distributor tube and screen, must be evacuated by other means.
 16. If replacing gravel, inspect lower distributor screens for damage and replace if necessary.
 17. To add new media and reconnect control valve to mineral tank follow General Installation steps 3-4K located on page 8 of this manual.
 18. Reconnect inlet, outlet, and drain plumbing to the control valve and tighten the plumbing union fittings on each of these plumbing lines.
 19. Reconnect brine tubing to brine connection port of control valve.
 20. Reconnect meter cable to meter. Then reconnect the other end of the meter cable to the flow meter port located on the top of the control board.
 21. If this is a CWSP-200HF series system reconnect any inter-connecting communication cables to the Comm in and Comm out ports located on the top of the control board.
 22. Open the inlet isolation valve slightly, until water can be heard flowing through the isolation valve and allow the mineral tank to fill with water. Air will come out of the drain line until the mineral tank is full of water. Once water flow at the drain line is observed, fully open the inlet valve and allow water flow to drain for 10 minutes to flush the resin bed of any color. If water at the drain shows any discoloration, continue to flush the resin bed until water at the drain is clear.
 23. After resin bed flushing is complete, reconnect the power supply cable to the power supply port located on the side of the control board. Plug the system back in to the power outlet so that it will return to the service position.
 24. Fully open inlet and outlet isolation valves and close bypass valve.
 25. Check for leaks and repair as required.
 26. Open hot and cold side of a treated water faucet to flush any air from the plumbing system.
- If this is an a CWSP-200HF series system replace media in each mineral tank according to this media replacement procedure.

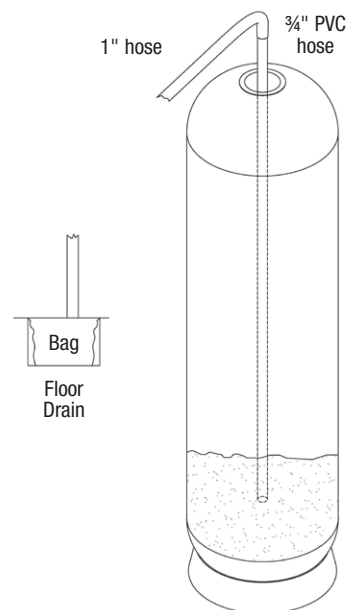

Replacement Parts - Major System Components

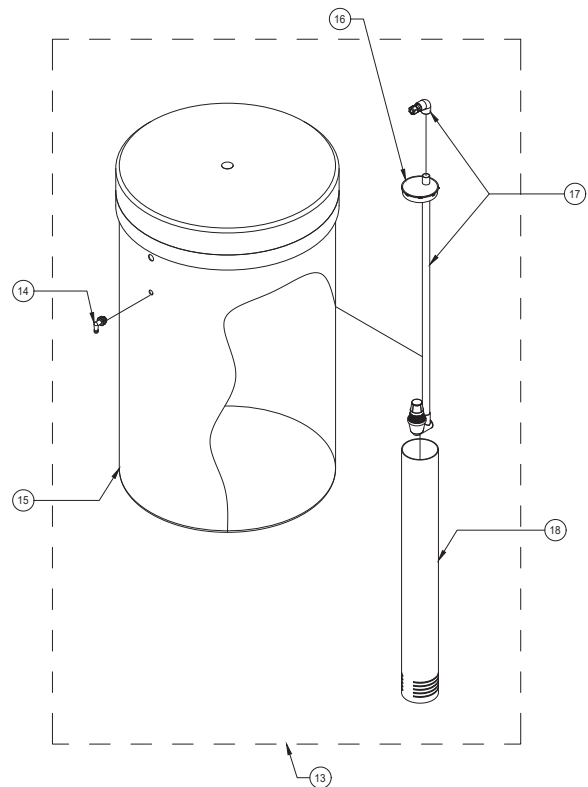
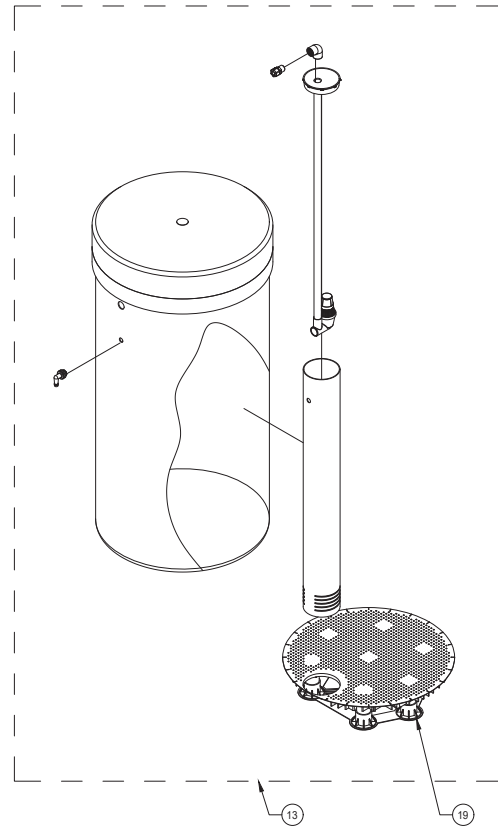
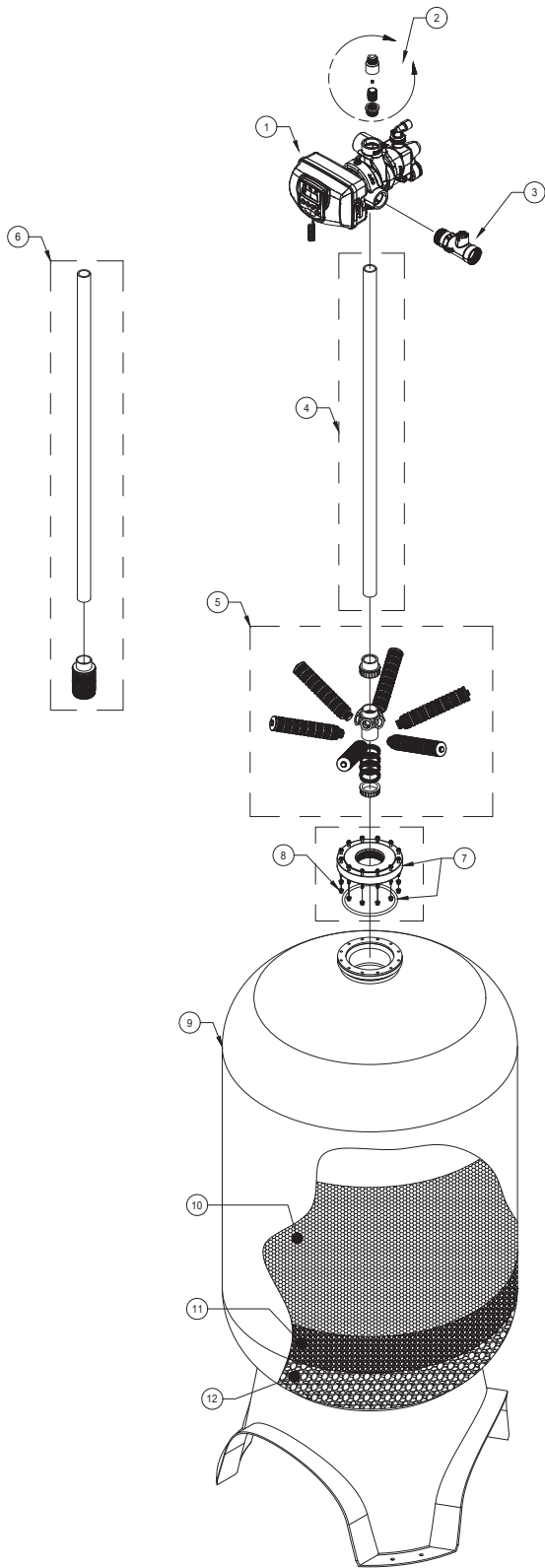

Replacement Parts - Major System Components

MAJOR SYSTEM COMPONENTS		
1	68104854	KC10V2HDMA VLV WS2H F/18 TNK WO/DLFC TNK BASE
2	68108487	V2003-A-MCH FC PVC 1 MXM HSG F/12 15 20 GPM (USE
2	68108500	V2005-A-25 FC PVC 1.50 MXM 25 GPM
2	68108498	V2005-A FC PVC 1.50 MXMHSG F/20-40 GPM (USE -GP
2	68108502	V2005-A-35 FC PVC 1.50 MXM 35 GPM
3	68104916	KC11V3050 VLV RMT MTR ELEC 2 SS 20KF
4	68103367	I7313 PIPE PVC SCH 40 1.5"
5	68101104	D2083 DIS KSH SO6-11 TMH&L/RING&CAP 36
6	68101197	D5007 DIS RISER R2A PP 1.5X72
7	68106677	Q9058 TANK ADAPT BUSHING 6" FLANGE X 4"#8 THREAD PVC W/ORING FOR 30" & 36" SOFTENERS
8	68101188	D3341 BOLT SET SS18-8 F/6 SF 12/.25X3 NUT FLAT L
9	68100698	C1031 FTK 24X72 NAT COMP4.0 TOP ONLY W/STD BASE
9	68100704	C1037-4T FTK 30X72 NAT COMP 4#8 TOP ONLY W/EXT B
9	68100706	C1038 FTK 36X72 NAT COMP 6.0FL TOP ONLY W/EXT BA
10	68100326	A4000 RSN C1 HICAP SOFTENER CATION
10	68100335	A4016 RSN C-100X10 (NA)STRONG ACID CATION(C3)
11	68100354	A7005A MEDIA GRAVEL FLINT #20 .125X.0625 50#/BAG
12	68100356	A7006A MEDIA GRAVEL .25X.125 50#/BAG
13	68102512	G2009A BRINE TANK ASSY 30X50 BLK W AIR CHECK FOR 1/2" BRINE HOSE
13	68102509	G2008C BRINE TANK ASSY 39X48 BLK W AIR CHECK FOR 1/2" BRINE HOSE
13	68102554	G3015-1 BRINE TANK ASSY 39X60 BLK W AIR CHECK FOR 1/2" BRINE HOSE
14	68102593	H1018 BRINE OVERFLOW SET WHT (2 PC) CLK
15	68102511	G2009 BRINE TANK 30X50 BLK EMPTY
15	68102507	G2008 BRINE TANK 39X48 BLK EMPTY
15	68102553	G3015 BRINE TANK 39X60 BLK EMPTY
16	68102592	H1017 BRINE WELL CAP 5"
17	68102634	H7007 BRINE SAFETY FLOAT BRINE VALVE AND AIR CHECK ASSY 2310 FOR 3/8" BRINE HOSE
17	68110335	K4560009-KIT AIR CHECK 900 & FITTING FOR 1/2" BRINE HOSE
18	68102606	H1071 BRINE WELL 5"X60" SLOTTED
18	68102602	H1033-60S BRINE WELL 5X60 SLOTTED
19	68102608	H1075 BRINE GRID SET FOR 24" DIAMETER BRINE TANKS INCLUDES 5" PVC LEGS
20	68104921	KC11V3064 PART WS2H/2L 4.0 BASE ASSY W/D1300-01

Replacement Parts - CWS-200HF Front Cover and Drive Assembly

FRONT COVER AND DRIVE ASSEMBLY

Drawing No.	Legacy No.	Description	Quantity
1	V3068-01	CWS-200HF POD FRONT/BACK COVERS	1
1a	V3082-01	CWS-200HF GRAPHICS POD ASY W/BRD*	Optional
2	V3241-02BOARD	CWS-200HF DISPLAY GRPH POD PCB REPL	1
3	V3248-01	CWS-200HF GRAPHICS POD CABLE	1
4	V3242-03BOARD	CWS-200HF VLV W/ MODBUS PCB REPL	1
5	V3224-01R	CWS-200HF COVER ASY PLATINUM	1
6	V3107-01	MOTOR ASY	1
7	V3226-01	CWS-200HF DRIVE BRACKET ASY	1
8	V3110	DRIVE GEAR 12X36	3
9	V3109	DRIVE GEAR COVER	1
Not Shown	V3461-02	CWS-200HF 24VDC 0.8A PWR SUPPLY	1
	V3461EU-02	CWS-200HF 24VDC 0.8A EU PWR SUPPLY	
	V3461UK-02	CWS-200HF 24VDC 0.8A UK PWR SUPPLY	
10	V4427	CWS-200HF PCB RELAY EXP KIT	Optional

*Contains items 1, 2 & 3 Pod Assembly, PC Board and Cable

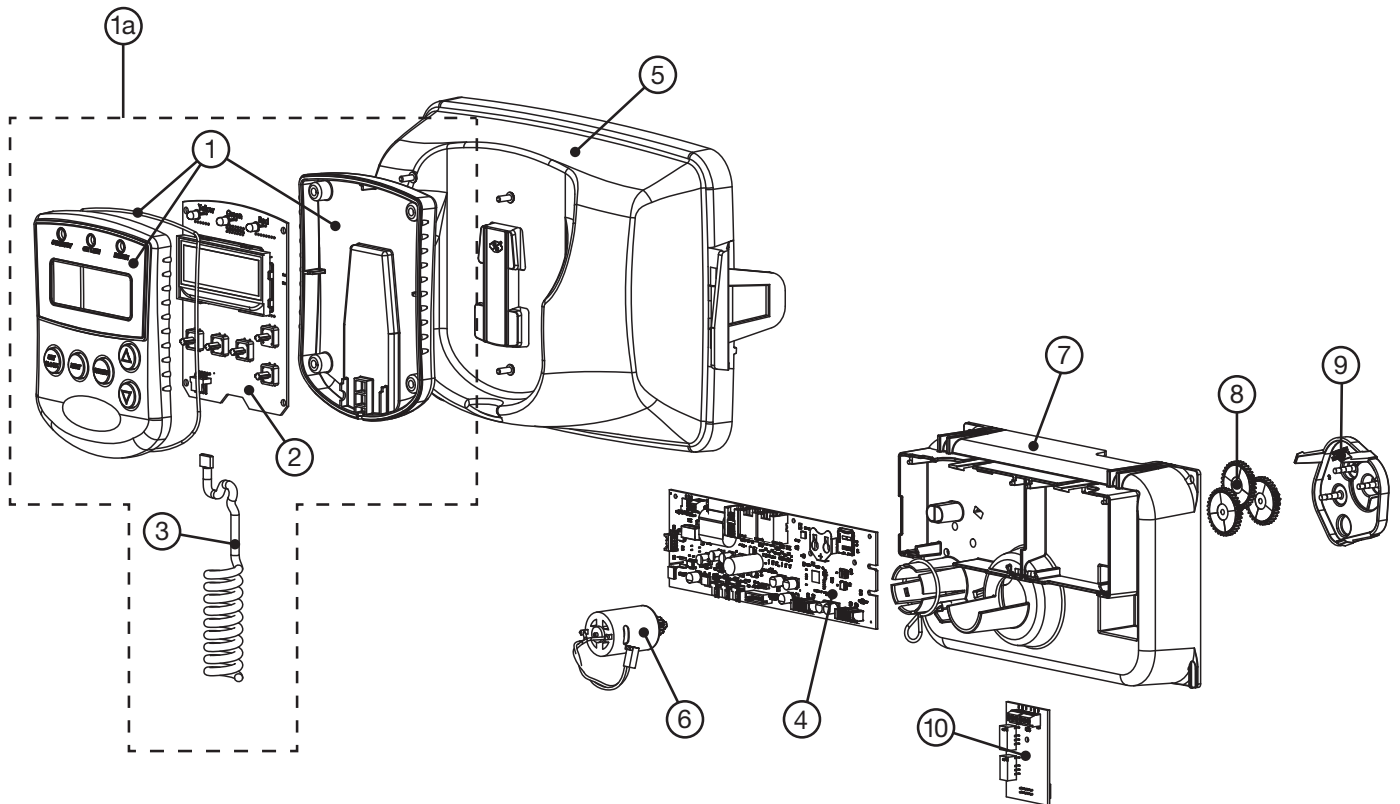

Replacement Parts - CWS-200HF Control Valve Body

DRIVE CAP ASSEMBLY, DOWNFLOW PISTON, REGENERANT PISTON, SPACER STACK
 ASSEMBLY, DRIVE BACKPLATE AND MAIN BODY

Drawing No.	Legacy No.	Description	Quantity
1	V3275	3/8-16 x 2 1/4 SS Screw	4
2	V3291	3/8 Washer SS	4
3	V3225	Backplate	1
4	V3093	Drive Assembly	1
5	V3289	Drive Cap O-ring	1
6	V3666-01	Main Piston	1
7	V3238-01***	Brine Piston	1
8	V3092	Seal Spacer Stack	1
Not Shown	V3468-04	1/4" Plug, NPT	2
	V3465-04	1/4" Plug, BSPT	
9	V3201-01HF	Main Body, NPT	1
	V3201BSPT-01HF	Main Body, BSPT	
10	V3279	Base O-ring	1
11	V3280	Riser O-ring NPT	1
	V3452	Riser O-ring BSPT	
12	V3054**	Base Clamp Assembly	1
13	V3276	Base Clamp Bolt 5/16-18 x 1 3/4 SS	1
14	V3269	Hex Nut 5/16-18 SS	1

**V3054 and V3091 CWS-200 4 IN BASE CLAMP ASY includes a V3276 CWS-200 BOLT HEX SS 5/16-18X1-3/4 and V3269 CWS-200 NUT 5/16-18 SS HEX.

***V3238-01 Brine Piston is used for Backwash Only valves.

THIS WATER METER SHOULD NOT BE USED AS THE PRIMARY MONITORING DEVICE FOR CRITICAL OR HEALTH EFFECT APPLICATIONS.

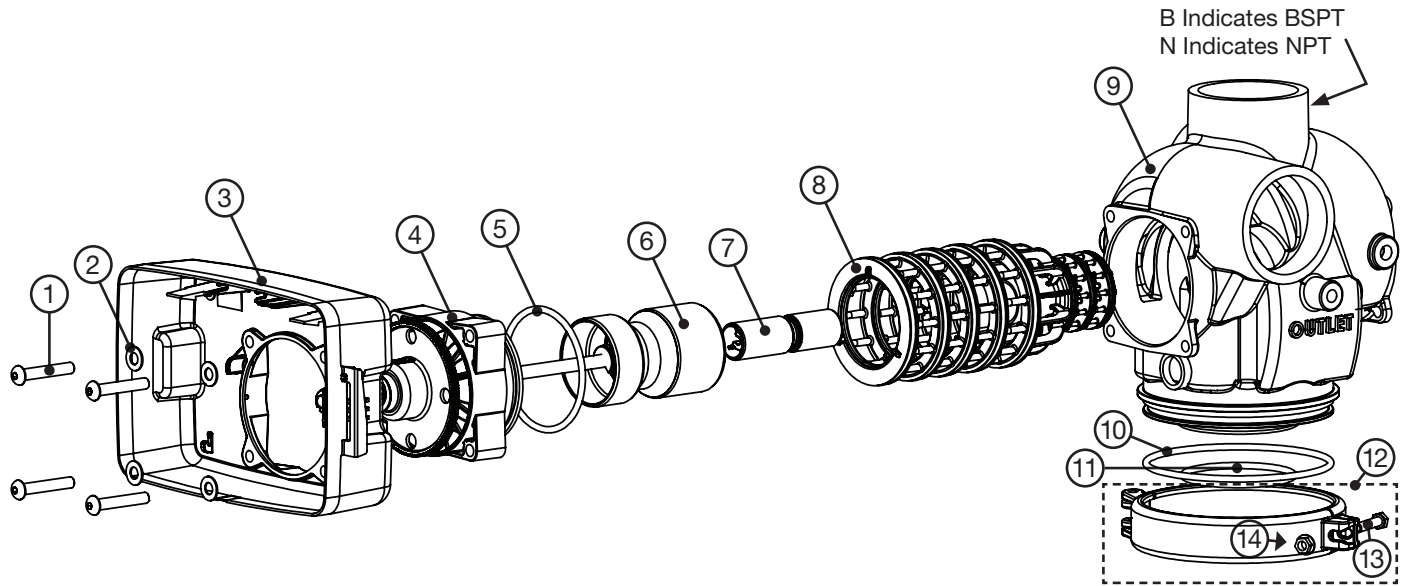

NOTICE

After completing any valve maintenance, press and hold NEXT and REGEN buttons for 3 seconds. This resets the electronics and establishes the service piston position. The display should flash all wording, then flash the software version and then reset the valve to the service position.

Replacement Parts - CWS-200HF Brine System

CWS-200HF BRINE VALVE BODY AND INJECTOR COMPONENTS

Drawing No.	Legacy No.	Description	Quantity
1	V3237-01	CWS-200HF SOFTFILL TUBE ASY	1
2	V3236-04*	CWS-200HF INJECTOR TUBE ASY FOR A THRU H	1
3	V3289	O-RING 344	1
4	V3067	CWS-200HF BRINE BODY ASY	1
5	V3477	CWS-200HF INJECTOR CAP	1
6	V3152	O-RING 135	1
7	V3275	CWS-200HF SCREW BSHD SS 3/8-16X2-1/4 (7/32" hex allen wrench required)	4
8	V3291	CWS-200HF WASHER SS 3/8	4
9	V3162-022**	WS1 DLFC 022 FOR 3/4	1
10	V3231	CWS-200HF REFILL FLOW CNTRL RETAINER	1
11	V3277	O-RING 211	1
12	V3105	O-RING 215	1
13	V3150	SPLIT RING	1
14	V3151	NUT 1 QC	1
15	V3149	FTG 1 MALE NPT ELBOW	NPT Only
	V3797	FTG 1 MALE BSPT ELBOW	BSPT Only
16	V3010-XX	See CWS-200HF and CWS-300H Valve Injector Order Information table below ²	1
17	V3499***	CWS-200HF FITTING CAP 1 IN THREADED	1
Not Shown	V3189	FTG 3/4&1 PVC SLVNT 90	Optional

* V3236-04 CWS-200HF INJECTOR TUBE ASY A thru H contains a V3285 O-RING 213 and a V3286 O-RING 216. CWS-300H BSPT valves manufactured before January 7, 2021 and CWS-300H NPT valves manufactured before August 25, 2021 use a V3670-01 Injector Tube. V3670-01 CWS-300H INJECTOR TUBE DOWNFLOW ASY contains a V3285 O-RING 213, V3286 O-RING 216 and a V3163 O-RING 019.

** Any V3162-XXX flow control may be used. V3237-01 CWS-200HF SOFTFILL TUBE ASY contains a V3155 O-RING 112, V3287 O-RING 110 and a V3288 O-RING 206.

*** Install V3499 on V3149 if valve is to be set up as a backwash only valve.

CWS-200HF VALVE INJECTOR ORDER INFORMATION

Order Number	Legacy Part Number	Typical Tank Diameter
68104902	V3010-2A	18"
68104903	V3010-2B	21"
68104904	V3010-2C	24"
68104905	V3010-2D	30"
68104906	V3010-2E	36"
68110549	V3010-2F	42"
68110384	V3010-2G	48"
N/A	V3010-2H	63"

¹ Actual injector size used may vary depending on the design and application of the system. Injectors in table are sized for a typical downflow softener using standard

² V3010-2A through V3010-2G injectors contain a V3283 O-RING 117 and a V3284 O-RING 114. V3010-2H injectors use a V3283 O-RING 117 and D1263 O-RING 116. Backwash Only Valves include a V3499 but do not include the following parts: V3189, V3162-022, V3231 and V3277.

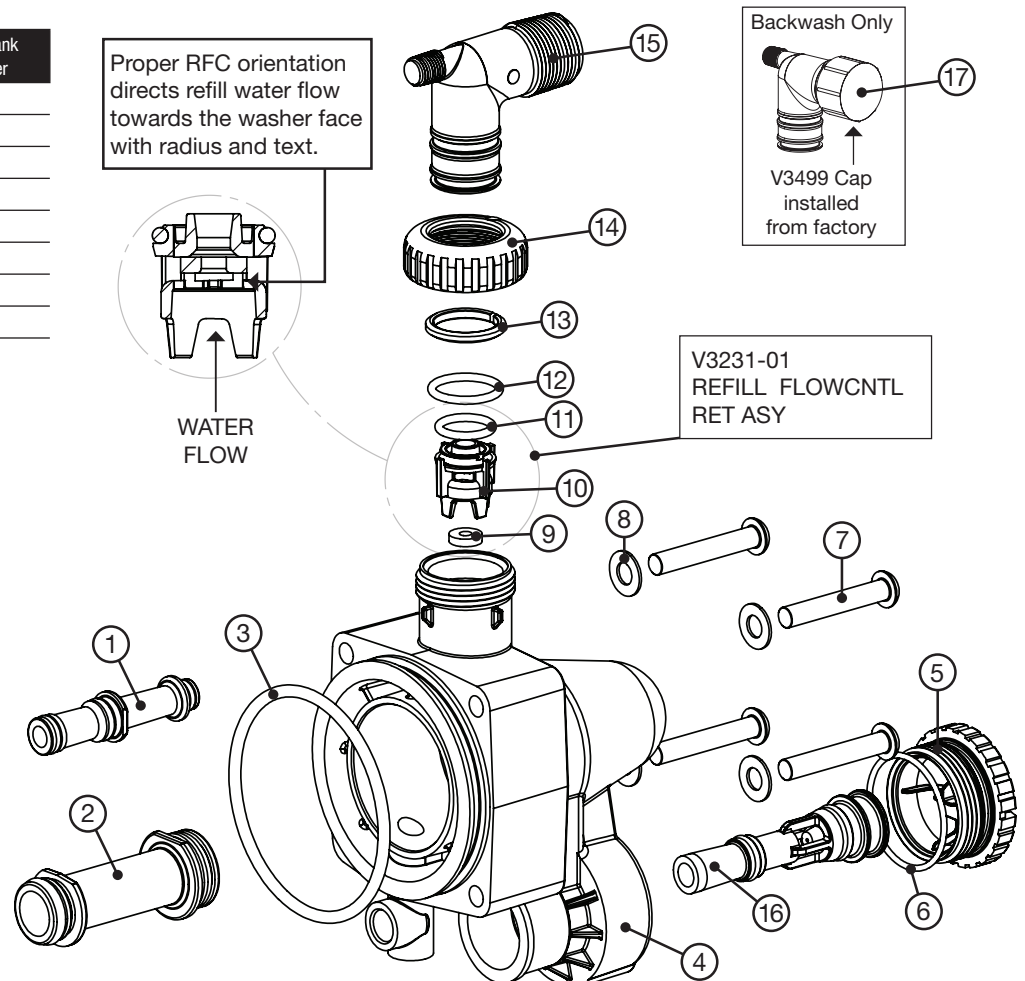

Replacement Parts - 2" Stainless Steel Mech/Electronic Meter

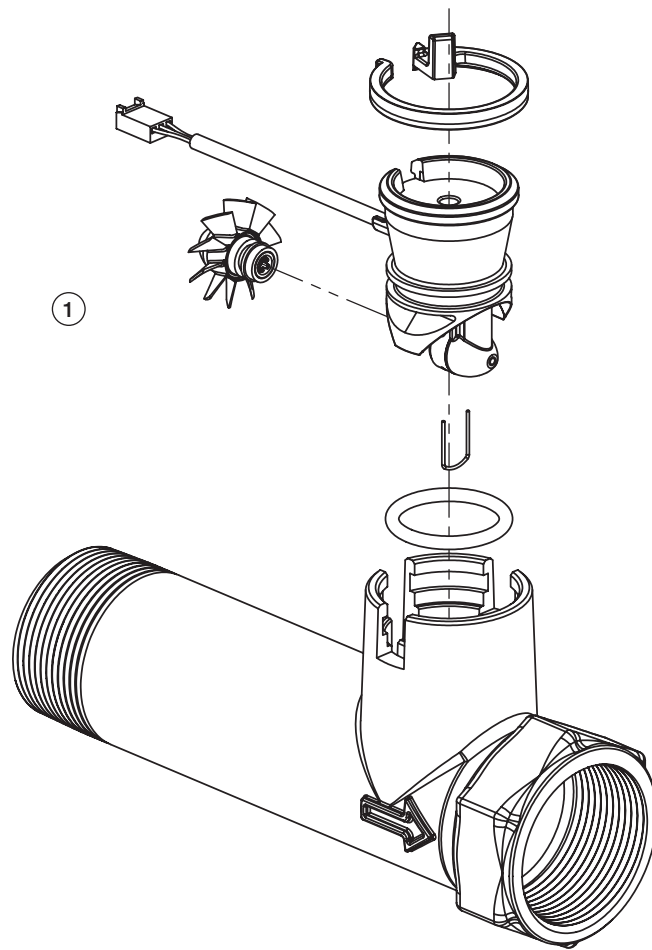

1½ INCH PLASTIC ELECTRONIC TURBINE METER ASSEMBLY

ITEM NO.	QTY	ORDERING CODE	DESCRIPTION
1	1	68104916	KC11V3050 ELECTRONIC TURBINE METER 2" FPT

Troubleshooting

CWS-200HF TROUBLESHOOTING GUIDE

CWS-200HF Error Codes

Possible Errors	
Code	Possible Errors
1001	No Encoder Pulses
1002	Unexpected Stall, Main Drive
1003	Run Time Too Long, Main Drive
14001	Message Queue Full
15003	Run Time Too Long, Bypass Drive
15010	Run Time Too Short, Bypass Drive Could Not Drive Offline
15011	Run Time Too Short, Bypass Drive Could Not Drive Online
16001	Communication Lost With Unit 2
16002	Communication Lost With Unit 3
16003	Communication Lost With Unit 4
18000	Reset Performed
18001	Power Loss
18002	Power Restored
20001	Run time too long, AUX drive
20002	Run time too short during unwind, AUX drive
20011	Run time too short, AUX drive
21XXX	System recovery from memory error

Troubleshooting

Problem	Possible Cause	Solution
1. No Display on POD	<ul style="list-style-type: none"> a. No power at electric outlet b. Control valve Power Adapter not plugged into outlet or power cord end not connected to PC board c. Improper power supply d. Poor connection between POD connector and PC Board. e. Defective Power Adapter f. Defective PC Board 	<ul style="list-style-type: none"> a. Repair outlet or use working outlet b. Plug Power Adapter into outlet or connect power cord end to PC Board connection c. Verify proper voltage is being delivered to PC Board d. Check connector on POD, possible broken wire or terminal pin not inserted properly in connector. Clean pins on PC Board by plugging and unplugging the POD connector a few times to remove excess protective coating. e. Replace Power Adapter f. Replace PC Board
2. POD does not display correct time of day	<ul style="list-style-type: none"> a. Power Adapter plugged into electric outlet controlled by light switch b. Tripped breaker switch and/or tripped GFI c. Power outage d. Defective PC Board 	<ul style="list-style-type: none"> a. Use uninterrupted outlet b. Reset breaker switch and/ or GFI switch c. Reset time of day d. Replace PC Board
3. Display does not indicate that water is flowing. Refer to user instructions for how the display indicates water is flowing	<ul style="list-style-type: none"> a. Bypass/ isolation valve in bypass position b. Meter is not connected to meter connection on PC Board c. Restricted/ stalled meter turbine d. Meter wire not installed securely into three pin connector e. Defective meter f. Defective PC Board 	<ul style="list-style-type: none"> a. Turn bypass/isolation handles to place in service position b. Connect meter to three pin connection labeled FLOW on PC Board c. Remove meter and check for rotation or foreign material d. Verify meter cable wires are installed securely into three pin connector labeled FLOW e. Replace meter f. Replace PC Board
4. Control valve regenerates at wrong time of day	<ul style="list-style-type: none"> a. Power outage b. Time of day not set correctly c. Time of regeneration set incorrectly d. Control valve set at "on 0" (immediate regeneration) 	<ul style="list-style-type: none"> a. Reset time of day. b. Reset to correct time of day c. Reset regeneration time d. Check programming setting and reset to dEL (for a delayed regen time)
5. Time of day flashes on and off	<ul style="list-style-type: none"> a. Power outage occurred 	<ul style="list-style-type: none"> a. Test voltage of Lithium Coin Cell Battery (new battery 3.0v+, dead battery 2.75vdc). Replace battery if needed and reset time of day.
6. Control valve does not regenerate automatically when the REGEN button is depressed and held.	<ul style="list-style-type: none"> a. Defective PC Board b. For the case of systems, another unit in regen would not allow another unit to go into regeneration 	<ul style="list-style-type: none"> a. Replace PC Board b. Wait for unit in regeneration to finish

Troubleshooting

Problem	Possible Cause	Solution
7. Control valve does not regenerate automatically but does regenerate when the REGEN button is depressed and held.	<ul style="list-style-type: none"> a. Bypass/isolation valves in bypass position b. Meter is not connected to meter connection on PC Board c. Restricted/ stalled meter turbine d. Incorrect programming e. Meter wire not installed securely into three pin connectors f. Defective meter g. Defective PC Board 	<ul style="list-style-type: none"> a. Turn bypass/isolation valve's handles to place in service position b. Connect meter to three pin connection labeled FLOW on PC Board c. Remove meter and check for rotation or foreign material d. Check for programming error e. Verify meter cable wires are installed securely into three pin connector labeled FLOW f. Replace meter g. Replace PC Board
8. Hard or untreated water is being delivered	<p>Check water quality directly at unit outlet</p> <ul style="list-style-type: none"> 1) Water quality is good <ul style="list-style-type: none"> a) Bypass/isolation valves are open or faulty 2) Water quality is poor <ul style="list-style-type: none"> a) Damaged seal/stack assembly b) Faulty riser tube or seal c) Control valve body type and piston type mis-matched 3) Media is exhausted, water quality is poor <ul style="list-style-type: none"> a) Higher than anticipated water usage b) Meter not registering c) No regenerant or low level of regenerant in regenerant tank d) Control fails to draw in regenerant e) Water quality fluctuation f) Fouled media bed 	<ul style="list-style-type: none"> 1) External Bypass Leak <ul style="list-style-type: none"> a) Fully close bypass/isolation valves or replace 2) Internal Bypass Leak <ul style="list-style-type: none"> a) Replace seal/stack assembly b) Verify seal placement & engagement with riser c) Verify proper control valve body type and piston type match 3) No internal leaks <ul style="list-style-type: none"> a) Check program settings or diagnostics for abnormal water usage b) See Troubleshooting Guide #3 c) Check refill setting in programming. Check refill flow control for restrictions or debris and clean or replace, check refill flow control rate for proper fill time. d) Refer to Troubleshooting Guide #12 e) Test water and adjust program values accordingly f) Replace media bed
9. Control valve uses too much regenerant	<ul style="list-style-type: none"> a. Improper refill setting or refill flow control is not sized properly b. Improper program settings c. Control valve regenerates frequently 	<ul style="list-style-type: none"> a. Check refill setting and check refill flow control for proper refill rate. b. Check program setting to make sure they are specific to the water quality and application needs c. Check for leaking fixtures that may be exhausting capacity or system is undersized

Troubleshooting

Problem	Possible Cause	Solution
10. Residual regenerant being delivered to service	<ul style="list-style-type: none"> a. Low water pressure b. Plugged, fouled, or incorrect injector size c. Restricted drain line d. Damaged seal/ stack assembly or piston allowing leakage during draw e. Draw time too short f. Excessive refill g. Vacuum leak in draw line/elbow 	<ul style="list-style-type: none"> a. Check incoming water pressure – water pressure must remain at minimum of 25 psi b. Inspect and clean or replace injector, or replace injector with correct size for the application c. Check drain line for restrictions or debris and clean d. Check seal/stack assembly and piston for damage and replace e. Program proper draw time needed f. Program proper refill time needed g. Locate vacuum leak and fix
11. Excessive water in regenerant tank	<ul style="list-style-type: none"> 1) Tank is being overfilled <ul style="list-style-type: none"> a) Improper program settings b) Missing refill flow controller 2) Previous regenerant is not being drawn out 	<ul style="list-style-type: none"> 1) Excess from fill cycle <ul style="list-style-type: none"> a) Verify program settings b) Visual inspection / measure volume output into container 2) See Troubleshooting Guide #12
12. Control valve fails to draw in regenerant	<ul style="list-style-type: none"> a. Injector is plugged b. Faulty regenerant piston c. Regenerant line connection leak d. Drain line restriction or debris causes excess back pressure e. Drain line too long or too high f. Low water pressure g. Damaged seal/stack assembly 	<ul style="list-style-type: none"> a. Remove injector and clean or replace b. Replace regenerant piston c. Inspect regenerant line for air leak d. Inspect drain line and clean to correct restriction e. Shorten length and/or height f. Check incoming water pressure – water pressure must remain at minimum of 25 psi g. Inspect seal/stack assembly for damage and replace
13. Water running to drain	<ul style="list-style-type: none"> a. Power outage during regeneration or unit is currently in regeneration b. Damaged seal/stack assembly c. Piston assembly failure d. Drive cap assembly not tightened properly 	<ul style="list-style-type: none"> a. Upon power being restored, control will finish the remaining regeneration time. Reset time of day. b. Replace seal/stack assembly c. Replace piston assembly d. Re-tighten the drive cap assembly

Troubleshooting

Problem	Possible Cause	Solution
<p>14. Err – 1001 = Control unable to sense motor movement</p>	<p>a. Motor not inserted fully to engage pinion, motor wires broken or disconnected</p> <p>b. PC Board not properly snapped into drive bracket</p> <p>c. Missing reduction gears</p> <p>d. Damaged or dirty reduction gear reflectors</p> <p>e. Faulty or dirty optics on back of PC board</p>	<p>a. Disconnect power, make sure motor is fully engaged, check for broken wires, make sure two pin connector on motor is connected to the two pin connection on the PC Board labeled REGEN. Press NEXT and REGEN buttons for about 3 seconds to resynchronize software with piston position.</p> <p>b. Properly snap PC Board into drive bracket and then Press NEXT and REGEN buttons for about 3 seconds to resynchronize software with piston position.</p> <p>c. Replace missing gears</p> <p>d. Clean or replace reduction gear</p> <p>e. Clean or replace PC Board</p>
<p>15. Err – 1002 = Control valve motor ran too short and was unable to find the next cycle position and stalled</p>	<p>a. Foreign material is lodged in control valve</p> <p>b. Mechanical binding</p> <p>c. Main white drive gear too tight</p> <p>d. Improper voltage being delivered to PC Board</p>	<p>a. Open up control valve and pull out piston assembly and seal/ stack assembly for inspection. Press NEXT and REGEN buttons for about 3 seconds to resynchronize software with piston position.</p> <p>b. Check piston and seal/ stack assembly, check reduction gears, check drive bracket and main drive gear interface. Press NEXT and REGEN buttons for about 3 seconds to resynchronize software with piston position. Check that pinion is not pressed up tight against motor.</p> <p>c. Loosen main drive gear. Press NEXT and REGEN buttons for about 3 seconds to resynchronize software with piston position. Verify free motion by rotating main drive gear by hand, driving piston in and out.</p> <p>d. Verify that proper voltage is being supplied. Press NEXT and REGEN buttons for about 3 seconds to resynchronize software with piston position.</p>

Troubleshooting

Problem	Possible Cause	Solution
16. Err – 1003 = Control valve motor ran too long and was unable to find the next cycle position	<ul style="list-style-type: none"> a. Motor failure during a regeneration b. Foreign matter built up on piston and stack assemblies creating friction and drag enough to time out motor c. Drive bracket not snapped in properly and out of position enough that reduction gears and drive gear do not interface 	<ul style="list-style-type: none"> a. Check motor connections then Press NEXT and REGEN buttons for about 3 seconds to resynchronize software with piston position. b. Replace piston and stack assemblies. Press NEXT and REGEN buttons for about 3 seconds to resynchronize software with piston position. c. Snap drive bracket in properly then press NEXT and REGEN buttons for about 3 seconds to resynchronize software with piston position.
17. Err - 14001 = Message queue full	<ul style="list-style-type: none"> a. LEAD PC Board did not receive a response from LAG units. 	<ul style="list-style-type: none"> a. Press NEXT and REGEN buttons for > 3 seconds to resynchronize software with piston position.
18. Err -15003 = MAV or NHWBP valve motor ran too long and unable to find the proper park position Motorized Alternating Valve = MAV No Hard Water Bypass = NHBP	<ul style="list-style-type: none"> a. Control valve programmed for ALT A or NHWBP without having a motorized drive securely connected to the 2-pin terminal labeled “BYPASS” on the main PC Board b. Poor wire connection c. Excess drag causing timeout before stall d. Motorized Bypass or MAV for NHBP motor not fully engaged with reduction gears 	<ul style="list-style-type: none"> a. Press NEXT and REGEN buttons for about 3 seconds to resynchronize software with piston position. Re-program valve to proper setting b. Remove power and check connection for Motorized Bypass or MAV for NHBP motor to PC Board two pin connection labeled BYPASS. Make sure wires in connector are inserted securely and no wires are broken. Clean pins on PC Board by plugging and unplugging the connector a few times to remove excess protective coating. Press NEXT and REGEN buttons for about 3 seconds to resynchronize software with piston position. c. Open Motorized Bypass or MAV for NHBP to check for obstructions d. Properly insert motor into casing, do not force into casing. Press NEXT and REGEN buttons for about 3 seconds to resynchronize software with piston position.

Troubleshooting

Problem	Possible Cause	Solution
<p>19. Err – 15010 = Motorized Bypass or MAV for NHBP valve motor ran too short (stalled) while trying to drive off-line</p> <p>Motorized Alternating Valve = MAV</p> <p>No Hard Water Bypass = NHBP</p>	<p>a. Foreign material is lodged in Motorized Bypass or MAV for NHBP valve</p> <p>b. Mechanical binding</p>	<p>a. Open up Motorized Bypass or MAV for NHBP and check for foreign material. Press NEXT and REGEN buttons for about 3 seconds to resynchronize software with piston position.</p> <p>b. Check drive cap assembly or piston and seal/ stack assembly, check reduction gears, drive gear interface, and check Motorized Bypass or MAV for NHBP black drive pinion on motor. Press NEXT and REGEN buttons for about 3 seconds to resynchronize software with piston position.</p>
<p>20. Err – 15011 = Motorized Bypass or MAV for NHBP valve motor ran too short (stalled) while trying to drive online</p> <p>Motorized Alternating Valve = MAV</p> <p>No Hard Water Bypass = NHBP</p>	<p>a. Foreign material is lodged in Motorized Bypass or MAV for NHBP valve</p> <p>b. Mechanical binding</p>	<p>a. Open up Motorized Bypass or MAV for NHBP and check for foreign material. Press NEXT and REGEN buttons for about 3 seconds to resynchronize software with piston position.</p> <p>b. Check drive cap assembly or piston and seal/ stack assembly, check reduction gears, drive gear interface, and check Motorized Bypass or MAV for NHBP black drive pinion on motor. Press NEXT and REGEN buttons for about 3 seconds to resynchronize software with piston position.</p>

Troubleshooting

Problem	Possible Cause	Solution
<p>21. # of units error: Communications has been broken with the unit specified in the error message. These errors are logged as 16K series errors as follows:</p> <p>16001: error with unit 2 16002: error with unit 3 16003: error with unit 4 16004: error with unit 5 16005: error with unit 6 16006: error with unit 7 16007: error with unit 8 16008: error with unit 9 16009: error with unit 10 16010: error with unit 11 16011: error with unit 12 16012: error with unit 13 16013: error with unit 14 16014: error with unit 15 16015: error with unit 16</p>	<p>a. System is programmed for the wrong number of units or a LAG unit is in “error # of units” mode due to loss of power.</p> <p>b. Poor connection on PC Boards</p> <p>c. More than one unit has determined that it is the LEAD unit</p>	<p>1) Correct all errors on LAG units before attempting to reset error on LEAD unit</p> <p>a. Pressing any button while in the # of units error will enter the user into the setting screen. Adjust to the correct units for the system and press NEXT to exit the setup screen. Press NEXT and REGEN buttons for about 3 seconds to resynchronize software with piston position. Re-program valve to proper setting.</p> <p>b. Make sure wires in connector are inserted securely and no wires are broken. Clean pins on PC Board by plugging and unplugging the connector a few times to remove excess protective coating. Press NEXT and REGEN buttons for about 3 seconds to resynchronize software with piston position.</p> <p>c. Press NEXT and REGEN buttons for about 3 seconds to resynchronize software with piston position. Then re-program each valve to operate as a single individual unit. Re-program the control that is to be the LEAD unit and it will filter down the programming to the LAG units automatically.</p>
<p>22. Err – 18000 = Reset was performed, this error code will display in the diagnostics under the error log</p>	<p>a. Reset performed.</p>	<p>a. You can view dates and times resets were performed</p>
<p>23. Err – 18001 = Power loss, this error code will display in the diagnostics under error log</p>	<p>a. When power is lost a signal is sent to log the power loss</p>	<p>a. You can view dates and times when power outage occurred</p>
<p>24. Err – 18002 = Power restored, this error code will display in the diagnostics under error log</p>	<p>a. When power is restored a signal is sent to log the power being restored</p>	<p>a. You can view dates and times when power outage occurred</p>

Troubleshooting

Problem	Possible Cause	Solution
25. Err – 20001 = AUX motor ran too long while trying to find proper park position.	<ul style="list-style-type: none"> a. Control valve programmed for NHBP or Separate Source without having a motorized drive securely connected to the 2-pin terminal labeled “AUX” on the main PC Board b. Poor wire connection c. Mechanical binding d. Motorized MAV for NHBP motor not fully engaged with reduction gears, should be flush top of gear cover. 	<ul style="list-style-type: none"> a. Press NEXT and REGEN buttons for about 3 seconds to resynchronize software with piston position. Then re-program valve to proper setting b. Remove power and check connection for MAV or NHBP motor to PC Board two pin connection labeled “AUX”. Make sure wires in connector are inserted securely and no wires are broken. Clean pins on PC Board by plugging and unplugging the connector a few times to remove excess protective coating. c. Press NEXT and REGEN buttons for about 3 seconds to resynchronize software with piston position. d. Properly insert motor into casing, do not force into casing twist while inserting. Press NEXT and REGEN buttons for about 3 seconds to resynchronize
26. Err – 20002 = AUX motor ran too long during unwind.	<ul style="list-style-type: none"> a. When Aux motor ran into stall it did not unwind to relieve the stress on the pistons position. 	<ul style="list-style-type: none"> a. Press NEXT and REGEN buttons for about 3 seconds to resynchronize software with piston position.
27. Err – 20011 = Motorized MAV or NHBP valve motor ran too short (stalled) while trying to drive online	<ul style="list-style-type: none"> a. Foreign material is lodged in MAV or NHBP valve b. Mechanical binding 	<ul style="list-style-type: none"> a. Open MAV or NHBP and check for foreign material. Press NEXT and REGEN buttons for about 3 seconds to resynchronize software with piston position. b. Check main drive assembly, remove motor and be sure white gear turns freely.
28. Err – 21xxx = System auto recovery from memory location errors	<ul style="list-style-type: none"> a. Memory location verifications were corrected 	<ul style="list-style-type: none"> a. You can view dates and times these occurred.

Water Softener Flow Diagrams - Down Flow Brining

CYCLE POSITIONS / FLOW DIAGRAMS SERVICE

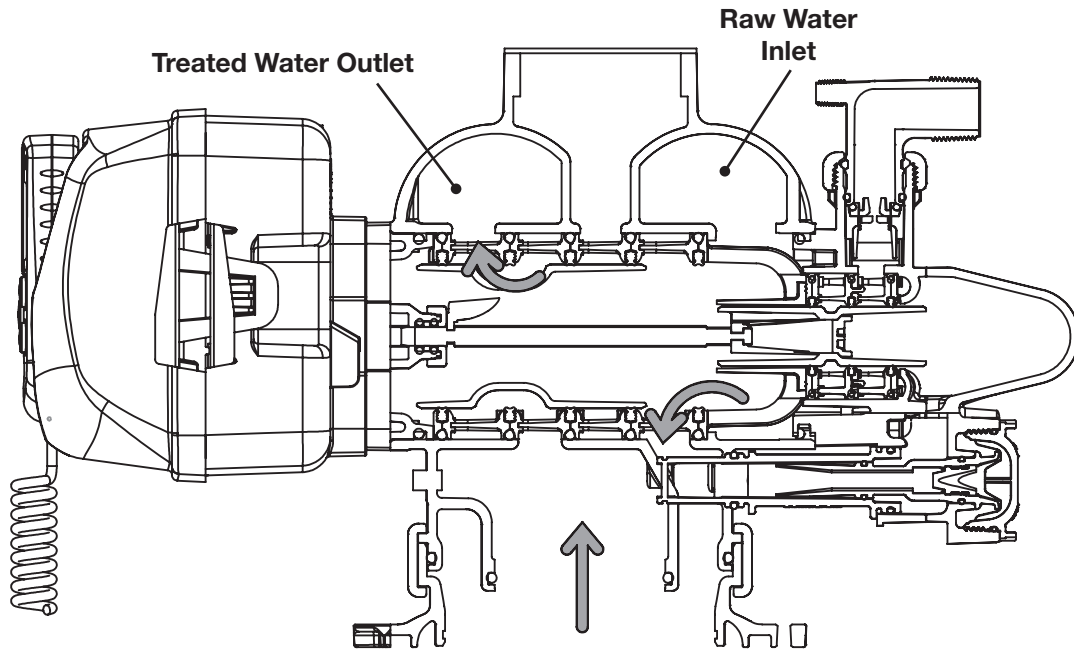

BACKWASH

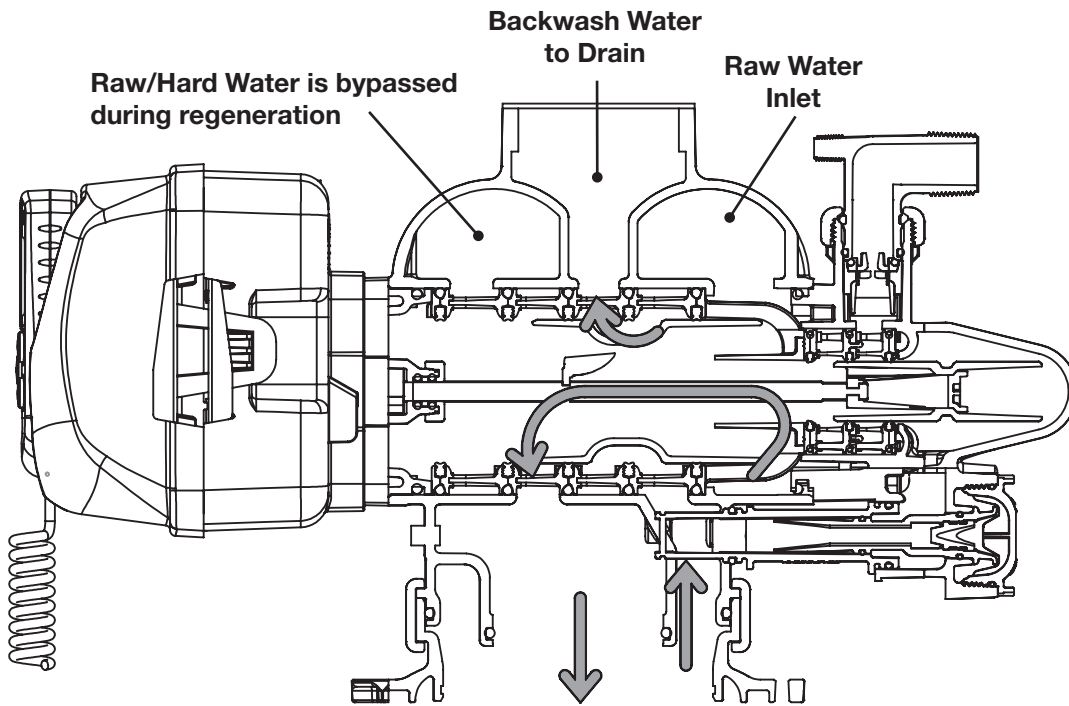

Water Softener Flow Diagrams - Up Flow Brining

CYCLE POSITIONS / FLOW DIAGRAMS (CONTINUED)

DRAW

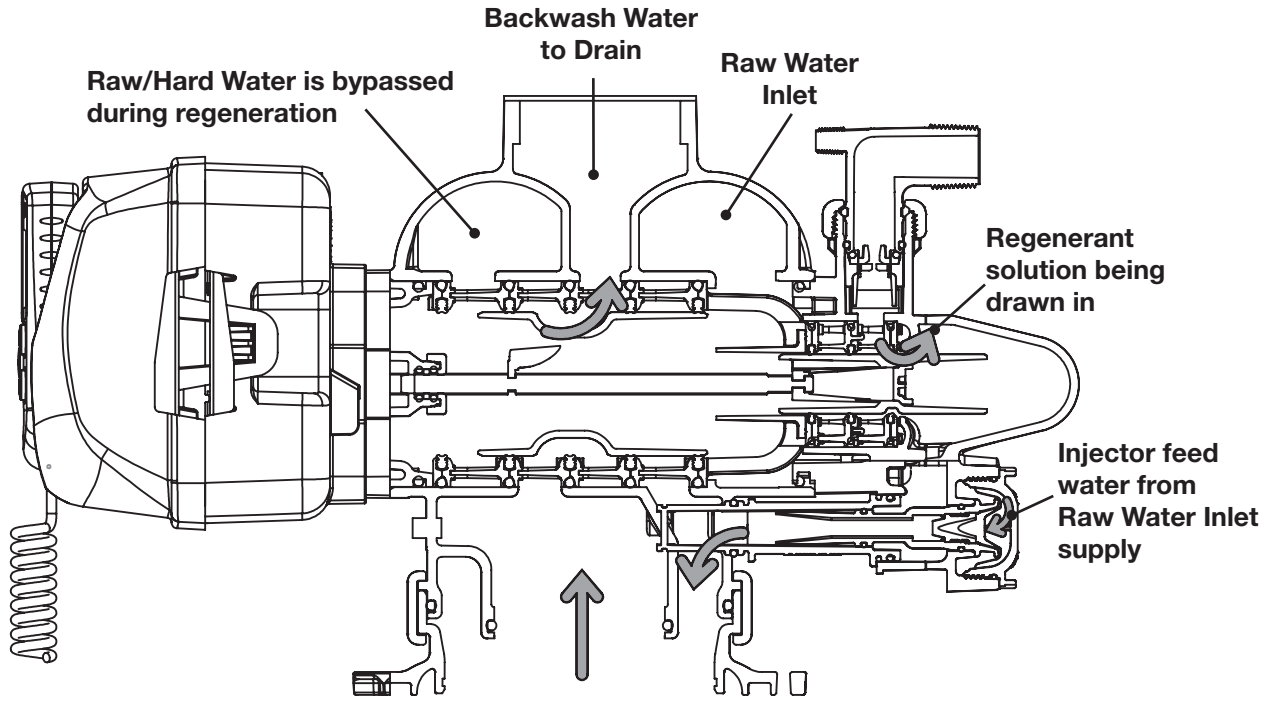

SLOW RINSE

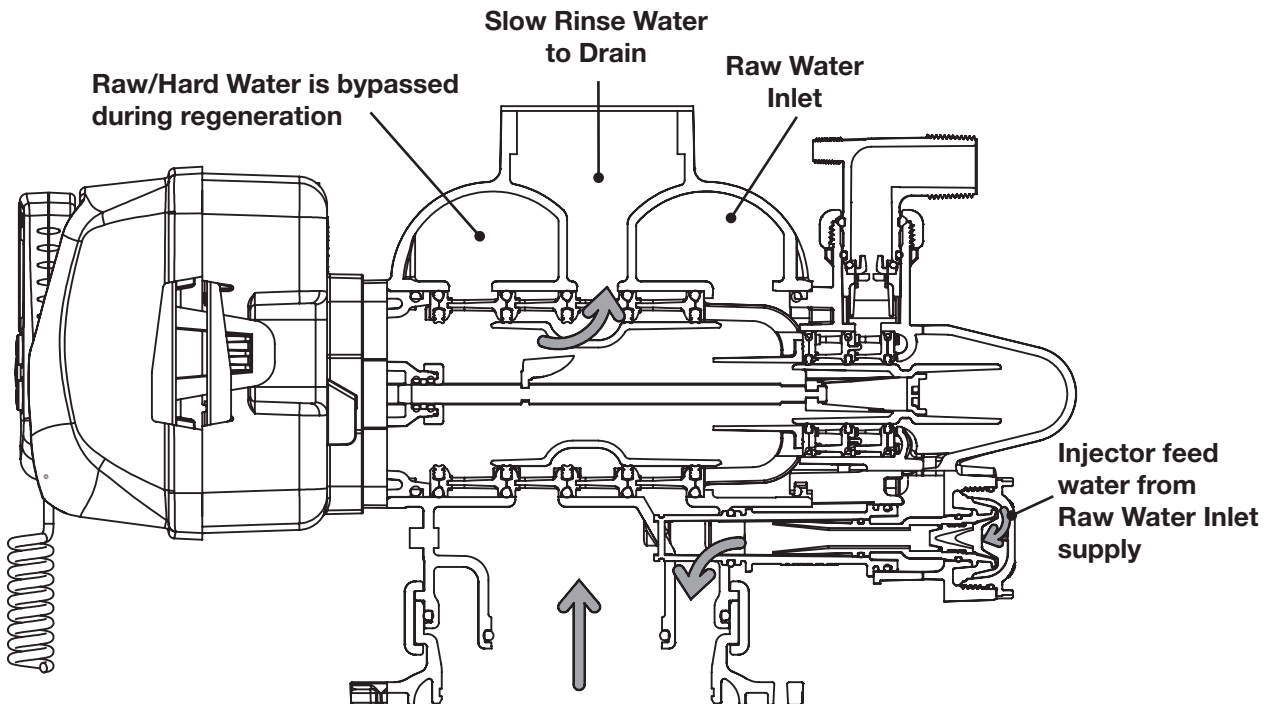

Water Softener Flow Diagrams - Down Flow Brining

CYCLE POSITIONS / FLOW DIAGRAMS (CONTINUED)

RINSE

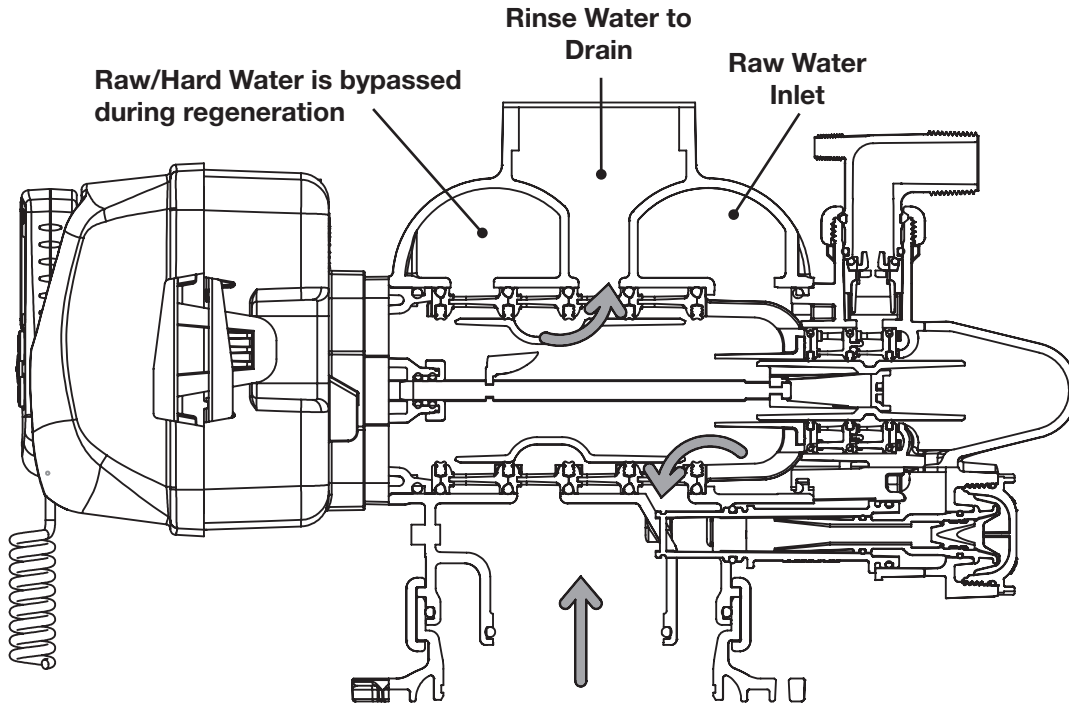

SOFT WATER REFILL

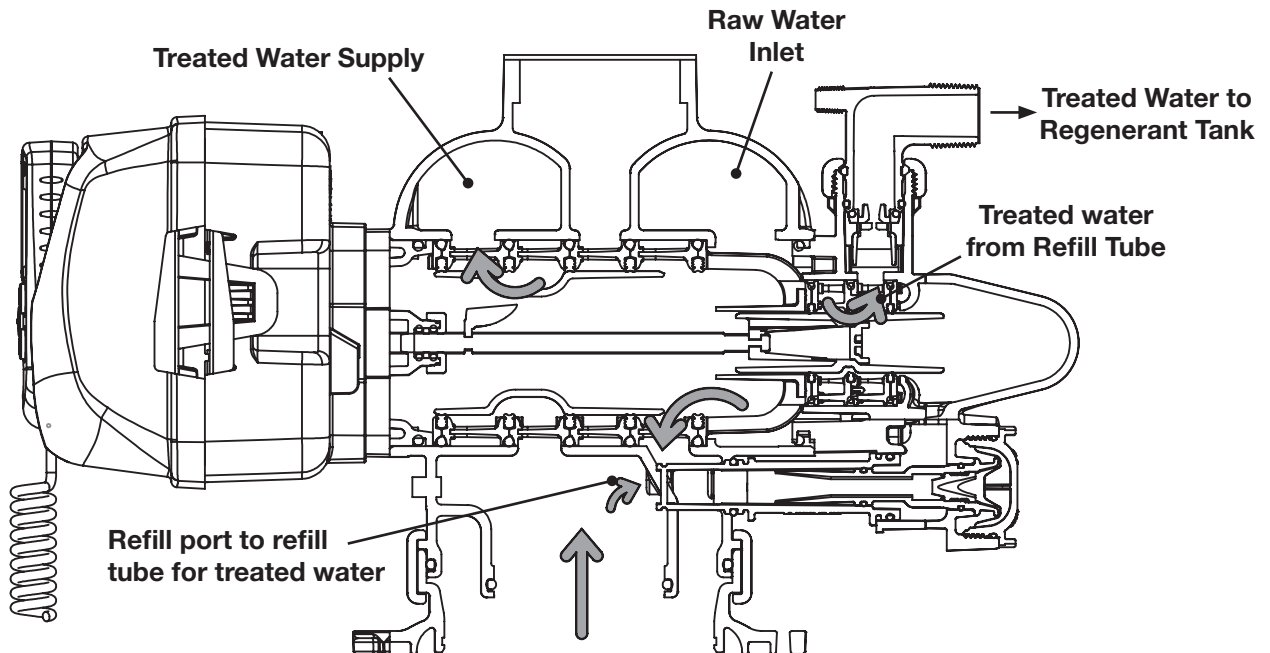

Injector Flow Data and Draw Rates

STANDARD INJECTOR GRAPHS

Order No. 68104902
US Units

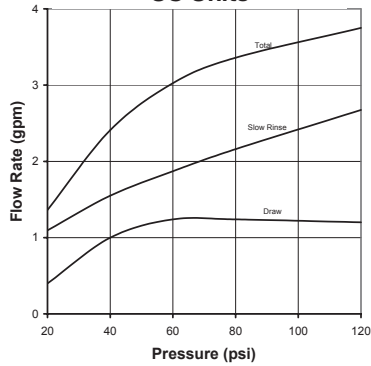

Order No. 68104903
US Units

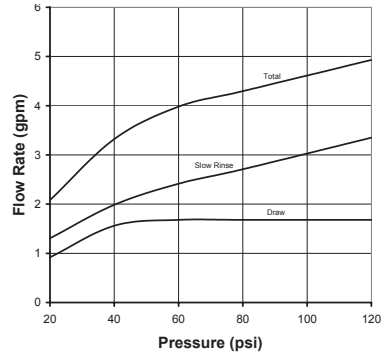

Order No. 68104904
US Units

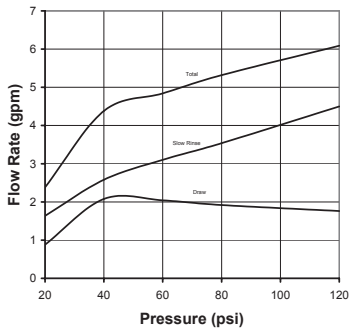

Order No. 68104905
US Units

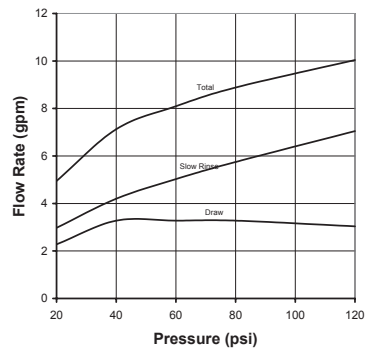

Order No. 68104906
US Units

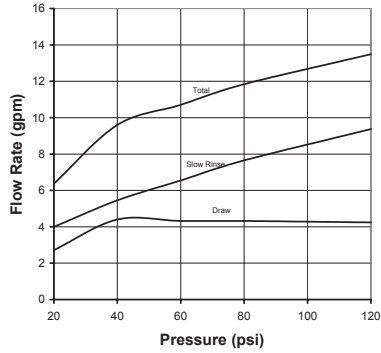

Order No. 68110549
US Units

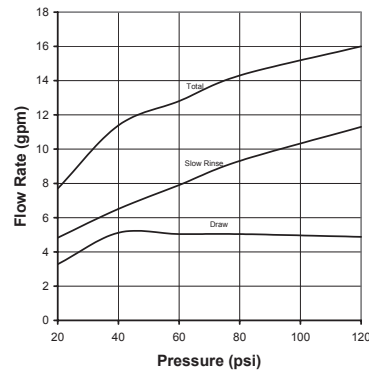

Order No. 68110384
US Units

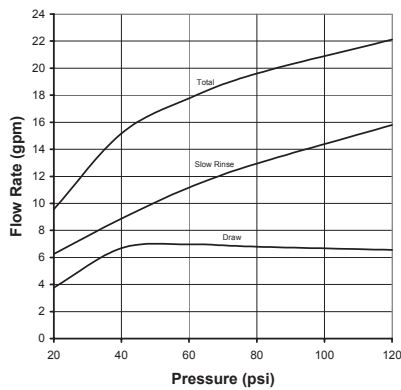

Order No. V3010-2H
US Units

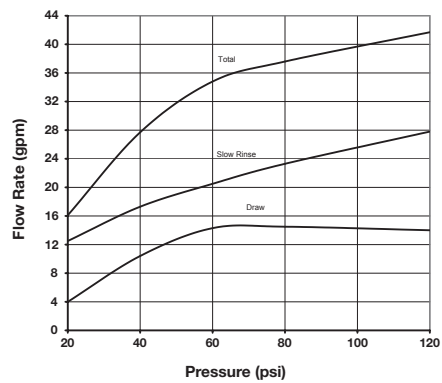

Injector Flow Data and Draw Rates

STANDARD INJECTOR GRAPHS (CONTINUED)

Order No. 68104902

Metric Units

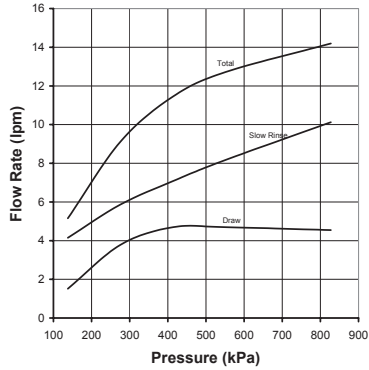

Order No. 68104903

Metric Units

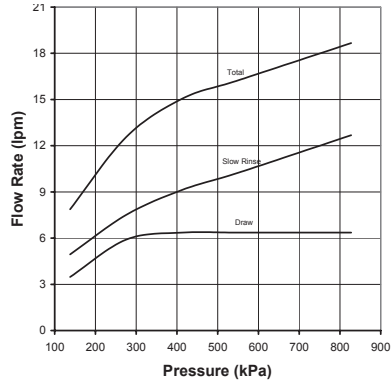

Order No. 68104904

Metric Units

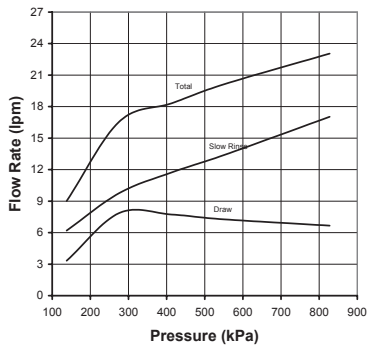

Order No. 68104905

Metric Units

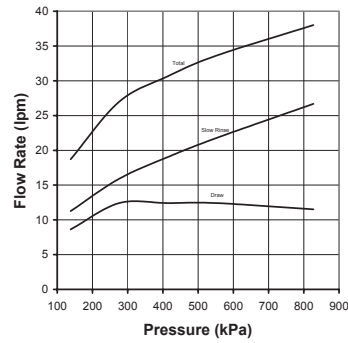

Order No. 68104906

Metric Units

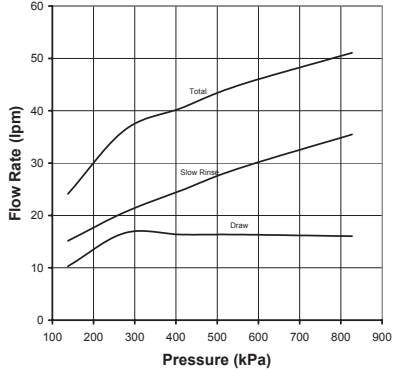

Order No. 68110549

Metric Units

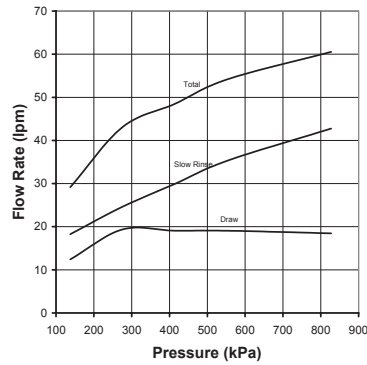

Order No. 68110384

Metric Units

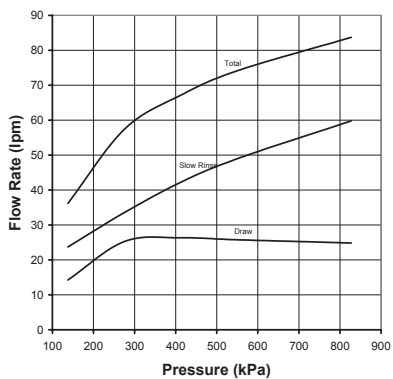

Order No. V3010-2H

Metric Units

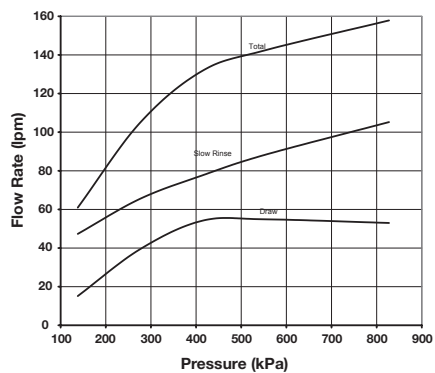

MAV Control

Twin Tank System, Simple Alternator (Sharing a MAV) System consists of 2 power heads, 1 communications cable and 1 MAV

Electrical Connections:

- The MAV's motor wire is connected to the 2-pin connector labeled BYPASS on Unit 2 (Unit B) PC board
- Using a standard straight through RJ45 cable (T-568B wiring), connect the "COMM OUT" of the LEAD control to the "COMM IN" of the LAG control (See page 17 for connector locations)
- If a single external meter is used, it should be connected to the 3-pin connector on Unit 2 (Unit B) labeled FLOW.

NOTICE When using a single external meter, "SYSTEM PULSES" and the proper pulse rate must be selected in the programming section

Electrical Connections:

- To regenerate with raw/treated water, the outlet of each unit is piped to the MAV. Port A will be piped to the LEAD (Unit A), Port B to the LAG (Unit B), and Port C to the common supply outlet.
- To regenerate with soft/treated water, the inlet of each unit is piped to the MAV. Port A will be piped to the LEAD (Unit A), Port B to the LAG (Unit B) and Port C to the common supply outlet.

If the piston rod is not visible, the current path of flow is between the "A" and "C" ports.

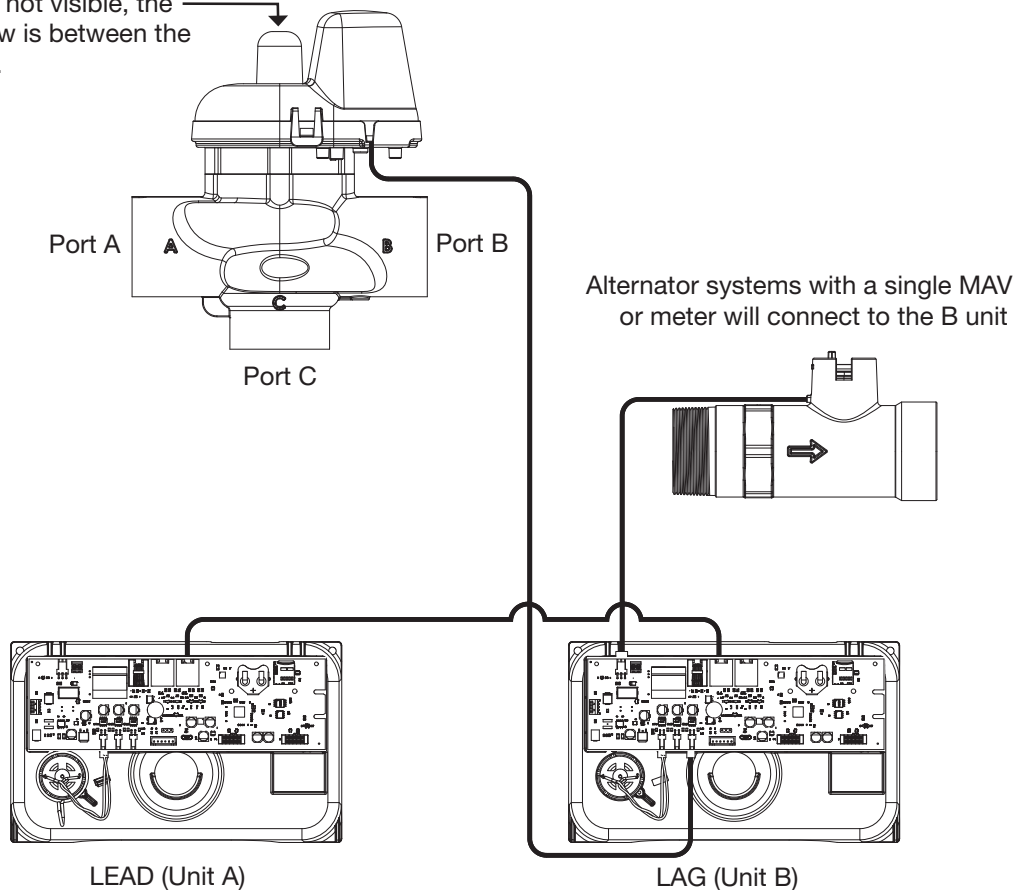

MAV Control continued

Multi-tank System, 3 Unit shown

System consists of 3 power heads, 2 communication cables and 3 No Hard Water Bypass (Isolation) valves

Electrical Connections:

- Each unit's isolation valve motor wire is connected to the 2-pin connector labeled BYPASS on each unit's PC board.
- Using two standard straight through RJ45 cables (T-568B wiring), connect the "COMM OUT" of the LEAD control to the "COMM IN" of LAG 1 and the "COMM OUT" of LAG 1 to the "COMM IN" of LAG 2 (See Page 6 for connector locations)

Plumbing Connections:

- To regenerate with raw/treated water, the isolation valve is piped into the outlet of each unit.
- To regenerate with soft/treated water, the isolation valve is piped into the inlet of each unit.

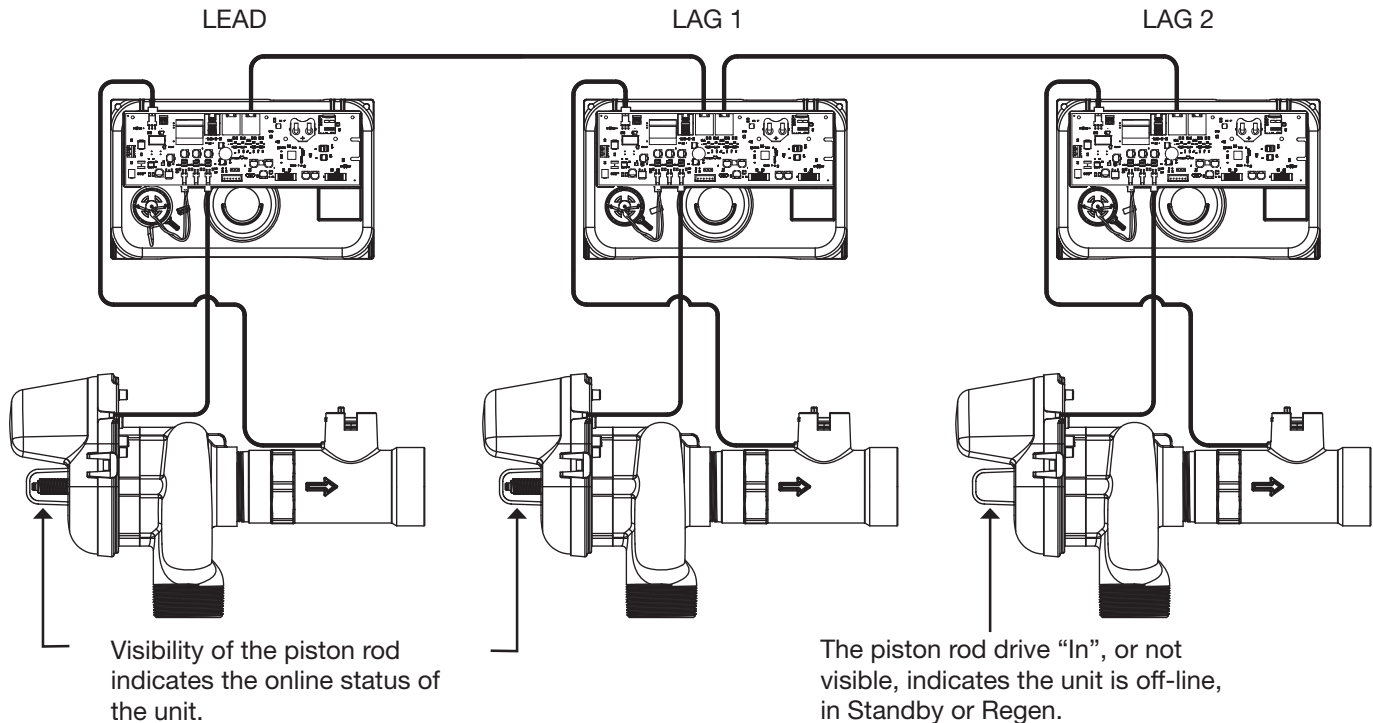

WATER SOFTENERS/FILTERS Limited Warranty:

The Company warrants each fiberglass tank 13 inches in diameter and smaller to be free from defects in material and workmanship under normal usage for a period of ten years from the date of original shipment.

The Company warrants each fiberglass tank 14 inches in diameter and larger to be free from defects in material and workmanship under normal usage for a period of five years from the date of original shipment.

The Company warrants any size Salt Tank (Brine Tank) to be free from defects in material and workmanship under normal usage for a period of five years from the date of original shipment.

The Company warrants each Control valve to be free from defects in material and workmanship under normal usage for a period of five years from the date of original shipment.

The Company warrants diaphragm valve nests and related controls to be free from defects in material and workmanship under normal usage for a period of one year from the date of original shipment.

The Company warrants all other components to be free from defects in material and workmanship under normal usage for a period of one year from the date of original shipment.

Water softener resins subjected to iron, manganese and chlorine levels greater than 1ppm are expressly not covered by this warranty. Manganese greensand media and expendable media such as activated carbon, Filox[®], Micro-Z[®] and neutralizing media are also not covered by this warranty. In the event of a covered defect within the warranty period, the Company will, at its option, replace or recondition the product without charge.

Disclaimer of Warranty. THE WARRANTY SET FORTH HEREIN IS GIVEN EXPRESSLY AND IS THE ONLY WARRANTY GIVEN BY THE COMPANY WITH RESPECT TO THE PRODUCT. THE COMPANY MAKES NO OTHER WARRANTIES, EXPRESS OR IMPLIED. THE COMPANY HEREBY SPECIFICALLY DISCLAIMS ALL OTHER WARRANTIES, EXPRESS OR IMPLIED, INCLUDING BUT NOT LIMITED TO THE IMPLIED WARRANTIES OF MERCHANTABILITY AND FITNESS FOR A PARTICULAR PURPOSE.

Limitation of Liability. The remedy described in the first paragraph of this warranty shall constitute the sole and exclusive remedy for breach of warranty, and the Company shall not be responsible for any incidental, special or consequential damages, including without limitation, lost profits or the cost of repairing or replacing other property which is damaged if this product does not work properly, other costs resulting from labor charges, delays, vandalism, negligence, fouling caused by foreign material, damage from adverse water conditions, chemical, or any other circumstances over which the Company has no control. This warranty shall be invalidated by any abuse, misuse, misapplication, improper installation or improper maintenance or alteration of the product.

Some States do not allow limitations on how long an implied warranty lasts, and some States do not allow the exclusion or limitation of incidental or consequential damages. Therefore the above limitations may not apply to you. This Limited Warranty gives you specific legal rights, and you may have other rights that vary from State to State. You should consult applicable state laws to determine your rights. **SO FAR AS IS CONSISTENT WITH APPLICABLE STATE LAW, ANY IMPLIED WARRANTIES THAT MAY NOT BE DISCLAIMED, INCLUDING THE IMPLIED WARRANTIES OF MERCHANTABILITY AND FITNESS FOR A PARTICULAR PURPOSE, ARE LIMITED IN DURATION TO ONE YEAR FROM THE DATE OF ORIGINAL SHIPMENT.**



Watts Regulator Co.

USA: T: (800) 659-8400 • N. Andover, MA 01845 • Watts.com

Canada: T: (888) 208-8927 • Burlington, ON L7L 5H7 • Watts.ca

Latin America: T: (52) 55-4122-0138 • Watts.com