

Engineering Specification

Job Name _____

Contractor _____

Job Location _____

Approval _____

Engineer _____

Contractor's P.O. No. _____

Approval _____

Representative _____

Series 994RPDA

Reduced Pressure Detector Assembly

2½" – 6"

Series 994RPDA Reduced Pressure Detector assembly is designed for use in accordance with water authority-containment programs. This series is normally used in health hazard applications to protect against backsiphonage and backpressure. This series can be used to prevent the reverse flow of fire protection substances, that is, glycerin wetting agents, foam agents, stagnant water, auxiliary supplies, and water of non-potable quality from being pumped or siphoned into the potable water supply.

The series includes a flood sensor to detect excessive water discharges from the relief valve. The sensor is installed on the assembly exterior and does not alter assembly functions or certifications. The sensor relays a signal that triggers notification to facility personnel for corrective action, thus limiting flooding and costly damage.

NOTICE

An add-on connection kit is required to activate the flood sensor. Without the connection kit, the flood sensor is a passive component that does not communicate with any other device. (A retrofit sensor connection kit is also available for existing installations. For more information, download RP/IS-994/994RPDA.)

Features

- Stainless steel construction provides long term corrosion resistance and maximum strength
- Stainless steel body is half the weight of competitive designs reducing installation and shipping costs
- Short end to end dimensions makes retrofit easy
- Bottom mounted relief valve reduces clearance requirements when installed against an outside wall
- Torsion spring check valves provides maximum flow at low pressure drop
- Thermoplastic and stainless steel check valves for trouble-free operation
- No special tools required for servicing
- Compact construction allows for smaller enclosures
- Stainless steel relief valve features a balanced rolling diaphragm to eliminate sliding seals and lower maintenance costs
- Detects underground leaks and unauthorized water use
- GPM or CFM meter available
- Sensor on relief valve for flood detection
- Flood alert feature activated with add-on sensor connection kit, compatible with BMS and cellular network communication

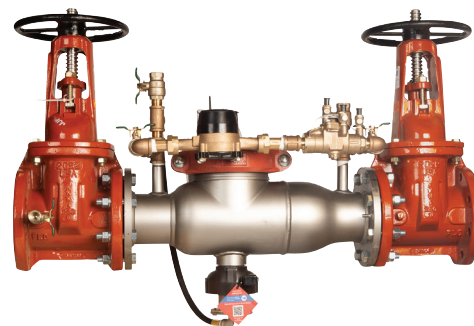

994RPDA-OSY-GPM with Flood Sensor

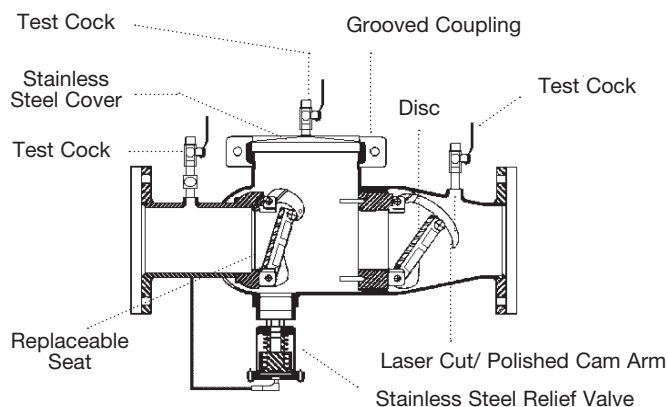

NOTICE

Use of the flood sensor does not replace the need to comply with all required instructions, codes, and regulations related to installation, operation, and maintenance of this product, including the need to provide proper drainage in the event of a discharge.

Watts is not responsible for the failure of alerts due to connectivity issues, power outages, or improper installation.

NOTICE

The information contained herein is not intended to replace the full product installation and safety information available or the experience of a trained product installer. You are required to thoroughly read all installation instructions and product safety information before beginning the installation of this product.

Inquire with governing authorities for local installation requirements.

Specification

A Reduced Pressure Detector assembly shall be installed at each cross-connection to prevent backsiphonage and backpressure of hazardous materials into the potable water supply. The assembly shall consist of a pressure differential relief valve located in a zone between two positive seating check valves. The main valve body shall be manufactured from 300 Series stainless steel for corrosion resistance. The check valves shall be of thermoplastic construction with stainless steel hinge pins, cam arm, and cam bearing. The check valve shall utilize a single torsion spring design to minimize pressure drop through the assembly. The check valves shall be modular and shall seal to the main valve body by the use of an O-ring. There shall be no brass or bronze parts used within the check assembly or relief valve. The use of seat screws to retain the check valve seat is prohibited. All internal parts shall be accessible through a single cover on the valve assembly securely held in place by a two-bolt grooved coupling. The differential relief valve shall be of stainless steel construction and shall utilize a rolling diaphragm and no sliding seals. The relief valve shall be bottom mounted and supplied with a steel reinforced sensing hose. The assembly shall include two resilient shutoff valves and four ball type test cocks and a hydraulically balanced bypass line. The bypass line shall include a meter, small diameter reduced pressure zone assembly and isolation valves. The bypass reduced pressure assembly shall have a single bolted on cover and top mounted test cocks. The assembly shall be a Watts Series 994RPDA, and shall include a sensor on the relief valve for flood detection.

Model/Option

FS	Sensor on relief valve for flood detection
LF	Without shutoff valves
OSY	UL Classified and FM Approved outside stem & yoke resilient seated gate valves
OSY FxG**	Flanged inlet gate connection and grooved outlet gate connection
OSY GxF**	Grooved inlet gate connection and flanged outlet gate connection
OSY GxG**	Grooved inlet gate connection and grooved outlet gate connection
CFM	Cubic feet per minute meter
GPM	Gallons per minute per meter

NOTICE

Watts recommends installing a drain line and the required 994AGK-P air gap for the drain line installation. When installing an air gap, attach the air gap brackets directly onto the food sensor. For more information, download the ES-AG/EL/TC specification at watts.com.

Materials

All internal metal parts	300 Series stainless steel
Main valve body	300 Series stainless steel
Check assembly	Noryl®
Flange dimension in accordance with AWWA Class D	

Pressure — Temperature

Temperature Range	33°F – 110°F (0.5°C – 43°C) continuous
Maximum Working Pressure	175 psi (12.1 bar)

Standards

AWWA C511-92, CSA B64.5

Approvals



**Options for the gate valve:

- Consult factory for dimensions.
- Available with grooved NRS gate valves; consult factory.
- Post indicator plate and operating nut available; consult factory.

Noryl® is a registered trademark of SHPP Global Technologies B.V.

Dimensions — Weights

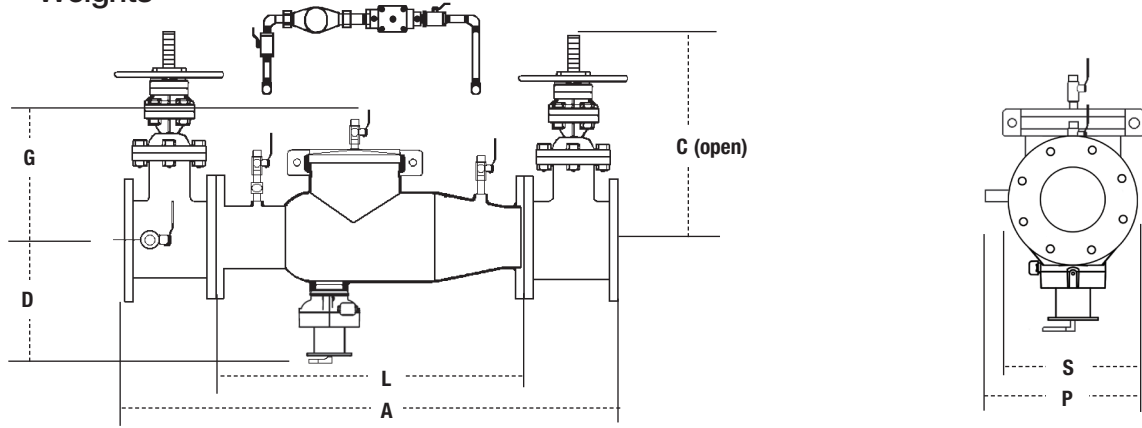

SIZE	DIMENSIONS				WEIGHTS													
	A		C		D		G		L		P		S		with Gates		without Gates	
<i>in.</i>	<i>in.</i>	<i>mm</i>	<i>in.</i>	<i>mm</i>	<i>in.</i>	<i>mm</i>	<i>in.</i>	<i>mm</i>	<i>in.</i>	<i>mm</i>	<i>in.</i>	<i>mm</i>	<i>in.</i>	<i>mm</i>	<i>lb</i>	<i>kg</i>	<i>lb</i>	<i>kg</i>
2½	37	940	16¾	416	10½	267	10	254	22	559	12½	318	7	178	170	77	61	28
3	38	965	18¾	479	10½	267	10	254	22	559	13	330	7½	191	205	93	65	29
4	40	1016	22¾	578	10½	267	10	254	22	559	14½	368	9	229	270	122	67	30
6	48½	1232	30¾	765	11½	292	11½	292	27½	699	15½	394	11	279	405	184	105	48

Capacity

Performance as established by Underwriters Laboratories.

*Typical maximum flow rate (7.5 ft/s)

**UL rated below

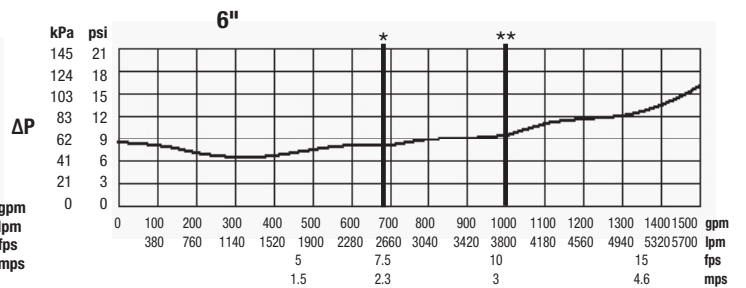
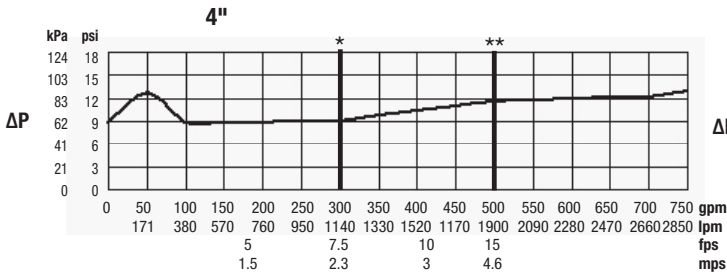
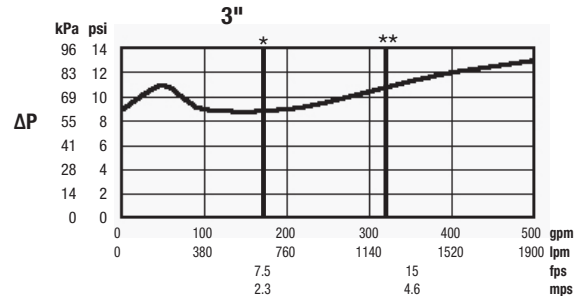
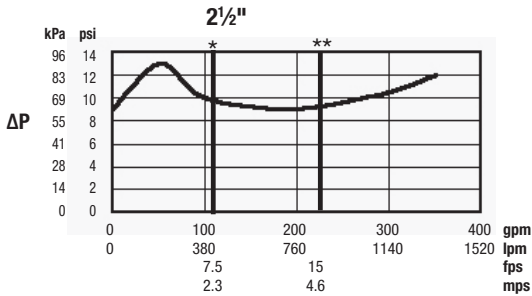

USA: T: (978) 689-6066 • Watts.com

Canada: T: (888) 208-8927 • Watts.ca

Latin America: T: (52) 55-4122-0138 • Watts.com