

iDROSET™ Series CSD

Precise, Tool-Less Balancing in Seconds
Application Guide

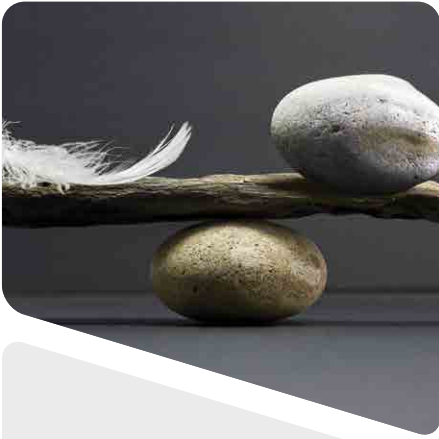



How to Balance a System with the iDROSET CSD Balancing Valve

Before Getting Started

- Completely flush out all circuits to remove any contaminants.
- Make sure all shutoff and control valves are fully open.
- Confirm that the system is full and the static pressure is high enough to avoid cavitation and vacuum points (minimum 5psi at the highest elevation of system).
- Make sure that the system is clear of any air.
- Place system pump(s) in operation.
- Set all pumps according to the desired maximum flow rate and maximum pump head. After balancing the system, the pump should be set to your preferred mode of operation.

NOTICE

The information contained herein is not intended to replace the full product installation and safety information available or the experience of a trained product installer. You are required to thoroughly read all installation instructions and product safety information before beginning the installation of this product.

→ The Role of the Compensation and Reference Valve

Once a balancing valve has been used to adjust the flow in one circuit of the system, a change in pump head pressure will cause the flow rate to change in the other circuits.

In order to avoid having to go back to the balanced valves every time the next one is set, install a valve on the return main of the system. This valve is the **compensation valve**, and the circuit with the highest pressure drop is used for the **reference valve**. Since iDROSET™ Series CSD doesn't need an external device, the process is simple:

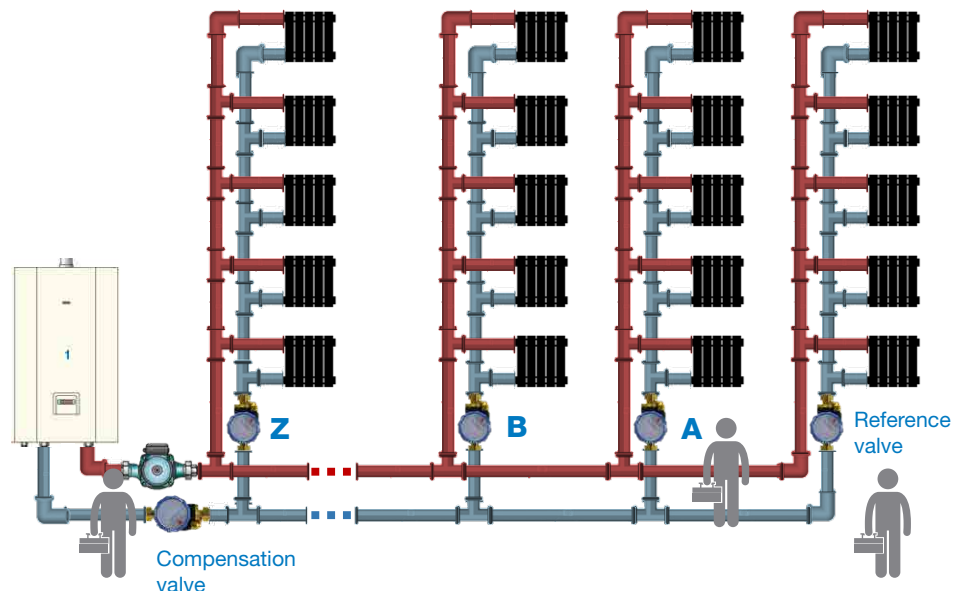

Ideally You'll Need 3 Operators

- One to check the reference valve
- One to control the compensation valve
- One to adjust all other valves

4 Step Process

1. The first operator sets the reference valve to the flow rate required by the project. If there is not enough flow rate because all the balancing valves are fully open, partially close the other balancing valves to increase flow through the reference valve.

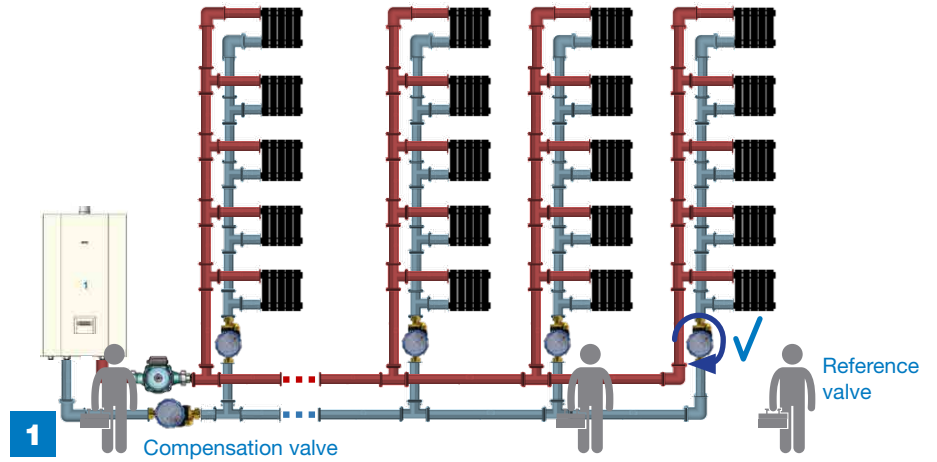

2a. The second operator adjusts the second valve to the flow rate required. This will create a variation of flow rate in the reference valve.

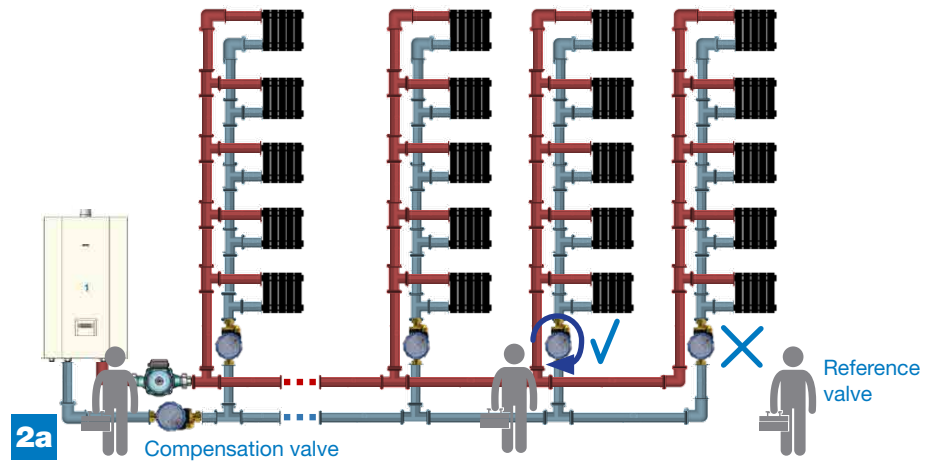

2b. The third operator adjusts the compensating valve until the reference valve is back to the required flow rate. (The flow rate is being visually controlled and communicated by the first operator).

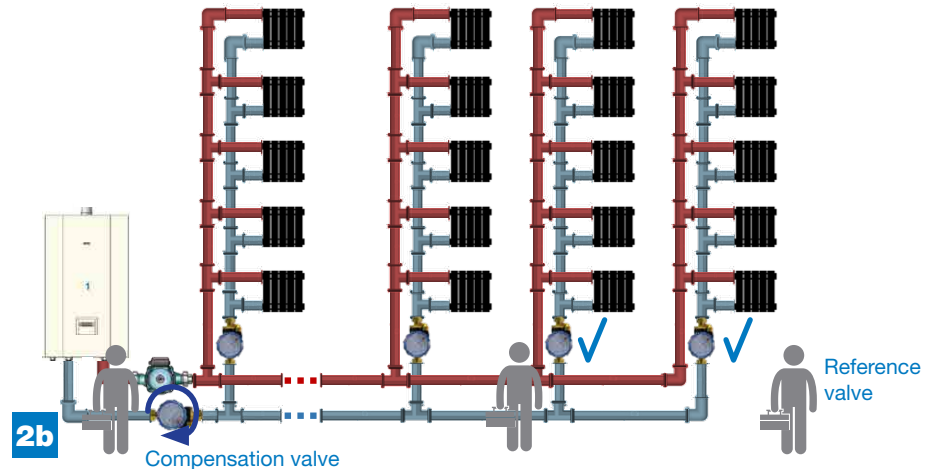

3a. Now that the two first valves have been adjusted to the correct flow rate, the second operator can adjust the flow rate of the next circuit. Just like before, the flow rate through the previously set valves will have changed.

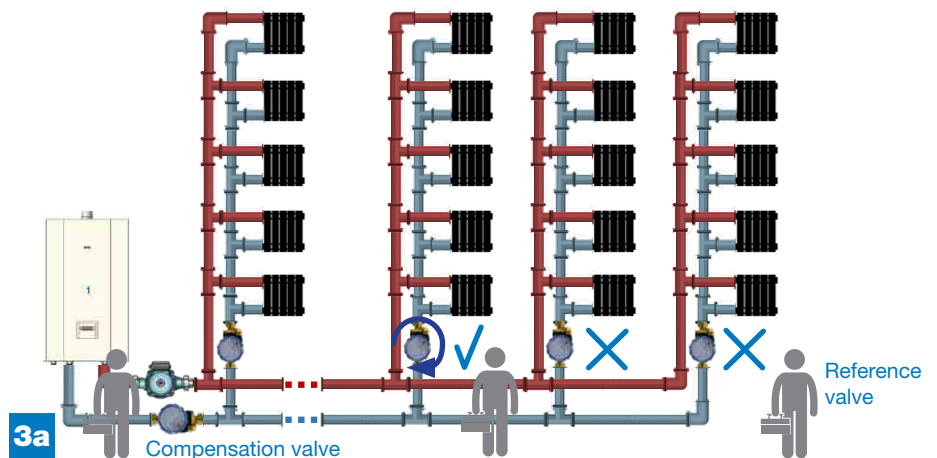

3b. The third operator adjusts the compensating valve until the reference valve reaches the required flow rate. (The flow rate being visually controlled and communicated by the first operator).

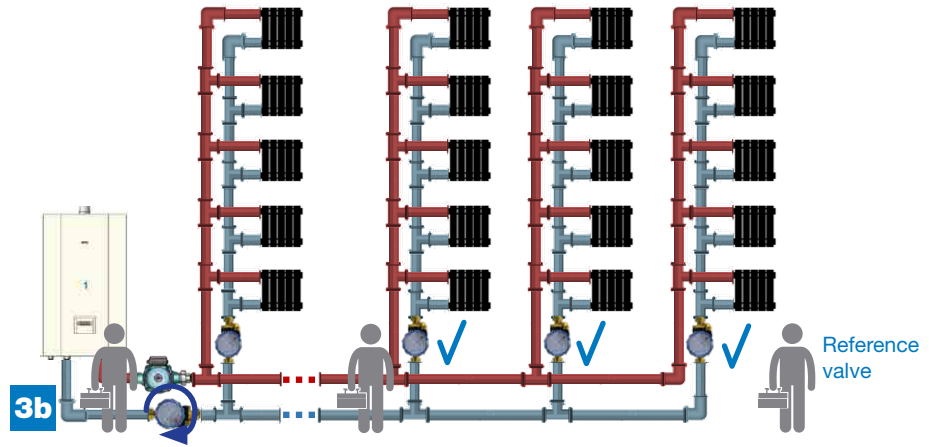

4. Continue this process until all valves have been adjusted. Once completed, every valve will be adjusted to provide the design flow rate.

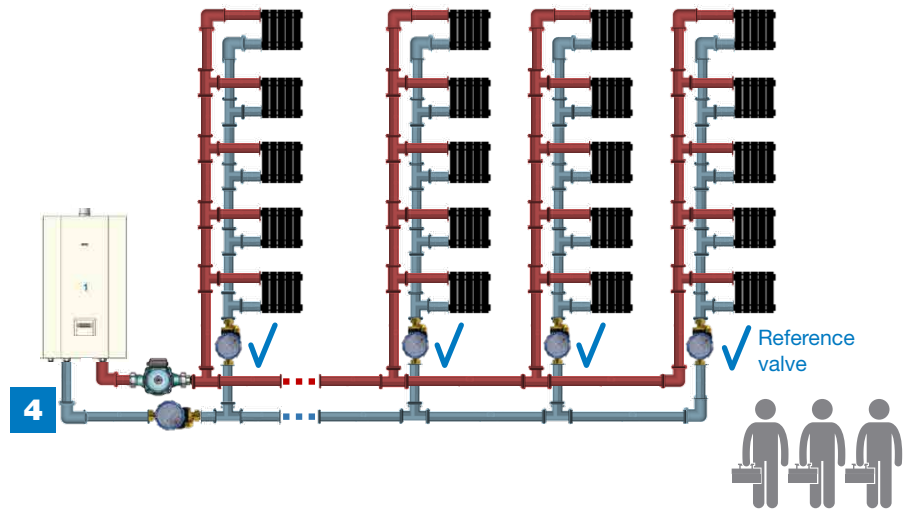

The descriptions and photographs contained in this product specification sheet are supplied by way of information only and are not binding. Watts reserves the right to carry out any technical and design improvements to its products without prior notice. Warranty: All sales and contracts for sale are expressly conditioned on the buyer's assent to Watts terms and conditions found on its website at www.watts.com. Watts hereby objects to any term, different from or additional to Watts terms, contained in any buyer communication in any form, unless agreed to in a writing signed by an officer of Watts.



USA: T: (978) 689-6066 • F: (978) 975-8350 • Watts.com
Canada: T: (888) 208-8927 • F: (905) 481-2316 • Watts.ca
Latin America: T: (52) 55-4122-0138 • Watts.com